

OSCILLOSCOPES

100 MHz Delta Time, Time Interval Averaging

Models 1740A, 1743A, 1745A, 1746A

- Delta time measurements
- Optional built-in DMM for increased accuracy & flexibility
- Dual channel, 5 mV/div to 100 MHz
- 3rd channel trigger view and selectable input impedance

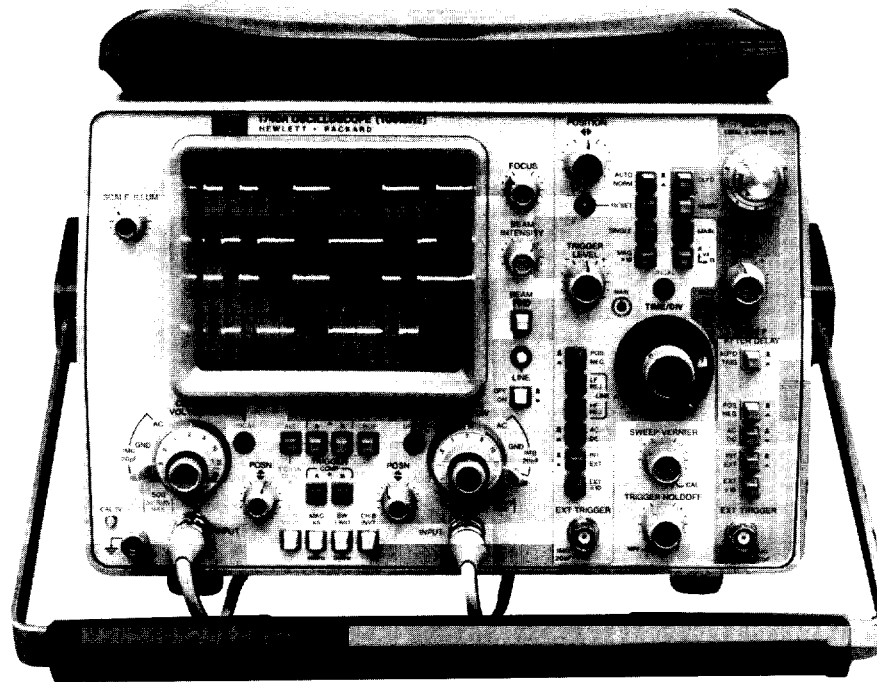

Description

The 1740 series of 100 MHz, dual-channel oscilloscopes have proven to be highly reliable measurement tools by passing the most complete testing program possible—years of use by satisfied customers. This reliable performance coupled with versatile measurement sets offer exceptional value for your time interval and general purpose oscilloscope needs over the long term.

The 1740s provide several measurement features which users have found to be particularly valuable. Both vertical channels provide 1 mV/div deflection factors with dc to 40 MHz bandwidth performance; the full 100 MHz performance is achieved with deflection factors of 5 mV/div to 20 V/div. Third channel trigger view, first offered in the 1740A, permits viewing of the trigger signal plus simultaneous viewing and timing of the external trigger signal with both vertical channels. A X10 horizontal magnifier provides main and delayed sweep speeds to 5 ns/div. . . . to allow full use of the 1740A's 100 MHz bandwidth amplifiers. These amplifiers have a Gaussian roll-off characteristic for accurate pulse response.

In addition, the 1740s offer a TV/video sync option that allows a variety of measurements to be made on complex video waveforms. There is also an optional auto-ranging DMM with 3½ digit resolution for ac/dc voltage, ac/dc current, and resistance measurements.

Individual Characteristics

1740A

The 1740A, which is the basic building block of the 1740 series, is a highly reliable general purpose 100 MHz oscilloscope. In addition to the family characteristics of the 1740 series, the 1740A uses a single-marker delayed sweep for time interval measurements.

The 1740A's front panel is laid out in a clear logical manner and has a color coding scheme that simplifies operation. The blue buttons control the display functions, while all trigger function buttons are green. Other controls are light gray or white, and the delayed sweep functions are highlighted with a shaded background.

To the oscilloscope user, the most critical component in the instrument is the cathode ray tube (CRT). The 8 x 10 cm CRT used in the 1740A has been perfected to the point where it has been described as

having "the brightest, crispest trace in the industry." Since the CRT is also the most expensive part of an oscilloscope, it is imperative that it be extremely reliable. With the 1740A, HP's CRT improvements have led to less than 1.4 failures per year per 1000 instruments — believed to be the best reliability record of any comparable CRT in industry.

1745A / 1746A

Both the HP model 1745A and 1746A oscilloscopes add a large screen CRT and a revised front panel to the time-tested instrument design of the 1740A. The new CRT offers a 43% larger viewing area while maintaining the same high standards of the 1740A trace quality. This provides more resolution for more accurate measurements, especially with multi-channel measurements that use third channel trigger view.

Voltage measurements are also simplified. The CRT graticule is 10 x 10 divisions instead of the more traditional 8 x 10 divisions. Full-scale voltage display is ten times the deflection factor - greatly reducing the amount of mental arithmetic required of the user.

The 1745A and 1746A both offer a neutral gray contrast screen which is heat-treated with a proprietary antireflection coating. You obtain bright, sharp trace definition without annoying light reflections. In keeping with the new CRT's contrast screen color, the color coding of the controls has also been changed. The dark buttons control the display functions while all trigger functions are medium gray. Miscellaneous functions are light gray and all delayed sweep functions are highlighted with a lightly shaded background.

The 1745A uses the familiar single-marker delayed sweep to perform time interval measurements. The 1746A adds HP's dual-marker delta time measurement capability for faster and more accurate timing measurements. When combined with the optional DMM, a direct readout of time interval measurements is provided in the LED display.

In the delta time mode, start and stop markers are alternately displayed on the intensified sweep. When the delayed sweep mode is selected, the region of the intensified markers is expanded and alternately displayed with the increased resolution of the faster delayed sweep. The waveforms are then positioned by adjusting the

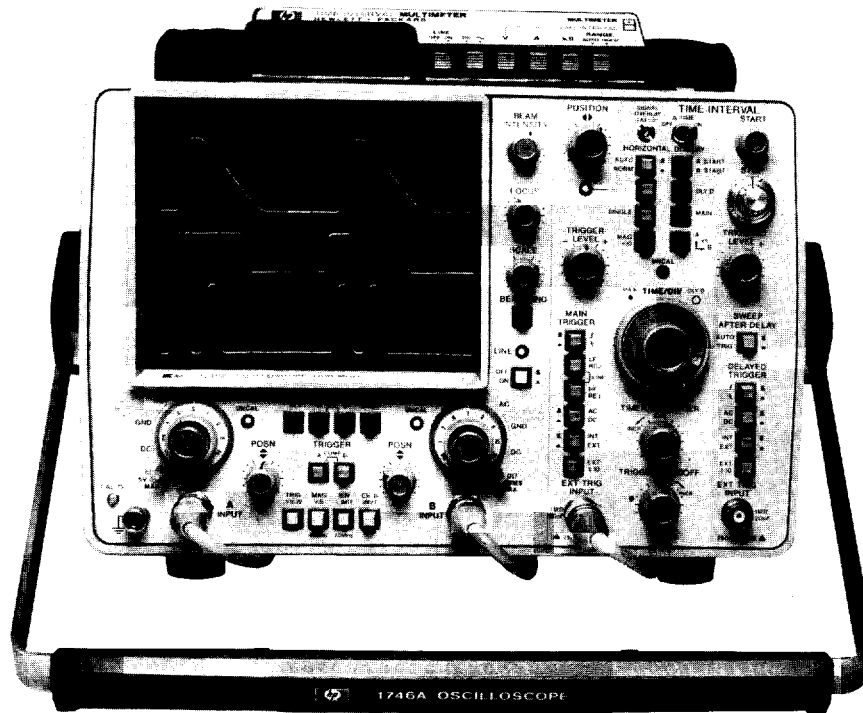

start and stop controls to make the measurements. For example, to make a pulse width measurement, the rising and falling edges are crossed at the 50% point. The answer is then obtained in one of three ways.

- 1) Multiply the helical stop control setting by the main sweep speed to obtain the answer. With this method, accuracy is approximately the same as with the single-marker method.
- 2) The 1746A has a rear panel voltage output which is scaled to represent the time interval between the start and stop markers. Using an external DMM to measure this voltage yields a direct readout of the time interval. This method is both easier and more accurate, approaching accuracies of $\pm 0.5\%$.
- 3) When the Option 034/035 DMM is added to the 1746A, the scaled voltage is measured directly by selecting the DMM time interval mode. Again measurement convenience is improved with accuracy approaching $\pm 0.5\%$.

In the dual-marker mode, time interval measurements can be made from Channel A to Channel B or from Channel B to Channel A when the alternate display mode is selected. A convenient switch lets you select whether the start marker is on Channel A or B.

In the three channel trigger view mode, the start marker is displayed on the trigger channel with time-coincident stop markers on each of the other two channels. This allows direct readings of time intervals between events on either channel and the external trigger input signal. Because there is a fixed delay (< 3.5 ns) between the external trigger and vertical signals, the accuracy of this time interval measurement can be improved by measuring this fixed delay and using it as a correction factor in subsequent measurements.

1743A

The 1743A adds to the feature set of the 1740A a delta time system based on a 100 MHz crystal oscillator rather than the traditional analog reference ramp. A time interval averaging technique increases both the accuracy and resolution of repetitive waveform measurements. This technique measures the time interval by accumulating counts from the 100 MHz crystal oscillator with a fundamental accuracy of ± 1 clock period (± 10 ns from a 100 MHz clock). However, by using a time interval averaging technique, the resolution of the measurement is increased by N, where N is the number of averages. At the three fastest sweep speeds, 10,000 intervals are averaged to

produce a measurement with a 100 ps resolution. The averaged time interval measurement is directly displayed on five-digit LED readout.

Time interval measurements relative to the leading edge of the first pulse in the main sweep display can be made with the 1743A. This first pulse measurement capability permits measurements between the trigger signal and the other two channels. In the trigger view mode, the start marker is on the trigger channel with the stop marker on each of the two channels at the same point in time. This allows timing measurements from the leading edge of an asynchronous signal, such as a strobe or flag, to resulting activity on Channels A and B.

The triggered delay mode of the 1743A offers excellent pulse width, period, and propagation delay measurement capability. The triggered delta sweep mode automatically performs the desired measurements without any of the complex operations usually needed with delayed sweep measurements. By selecting the appropriate start and stop slopes (one positive and one negative for width measurements and both the same for period measurements) you can conveniently read out the period or width measurement while directly viewing the exact trigger level at which the measurement is being made.

Also available is the ability to make duty cycle measurements quickly. In the intensified mode, measure the pulse width and period with the direct LED readout. Then a simple ratio calculation provides an accurate answer.

Family Characteristics

Third Channel Trigger View

In many measurements, especially in digital applications, it is desirable to trigger the main sweep externally using a signal synchronous with the displayed waveforms. The third channel trigger view offers several measurement conveniences in timing applications:

- 1) The trigger threshold can be viewed relative to the trigger waveform for either an internal or external trigger source. Trigger threshold is the center horizontal graticule line and the trigger point is selected by positioning the trigger waveform vertically on the reference graticule line using the Main Sweep Trigger Level control. This also allows you to view the shape of the trigger waveform to verify that the correct signal is used as the trigger source and that the trigger threshold is not set to portions of a waveform containing irregularities and reflections.

OSCILLOSCOPES

100 MHz Delta Time, Time Interval Averaging

Models 1740A, 1743A, 1745A, 1746A

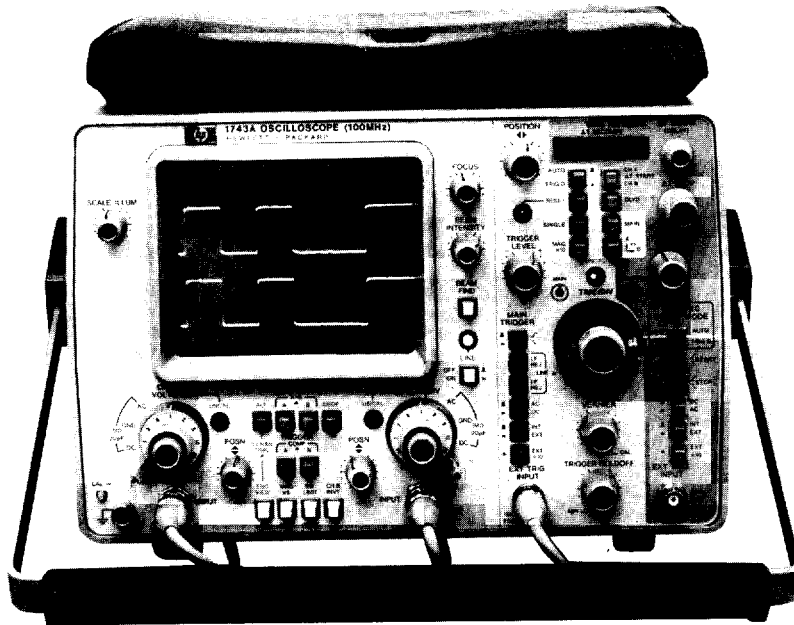

2) With trigger view, three channels of information are displayed so that timing relationships can be analyzed. The displayed trigger signal has a specified delay of <3.5 ns relative to the two vertical channels.

Stable Flexible Triggering

Stable internal triggering to greater than 100 MHz requires only one division of vertical deflection. The internal trigger signal is picked off immediately after the attenuator which assures a stable display regardless of changes in position, vernier, or polarity controls. Easy to use pushbutton trigger controls assure you of the desired signal conditioning for your measurement applications. In the external trigger mode, signals of only 100 mV trigger the oscilloscope to 100 MHz (only 50 mV to 50 MHz). In the composite trigger mode, the oscilloscope internally triggers on asynchronous signals without the need to overlap the traces vertically or use additional conditioning controls.

Vertical Amplifiers

Vertical deflection factors from 5 mV/div to 20 V/div assure that the majority of signals can be easily displayed. For low level signals, a times five magnifier offers dual-channel deflection factors of 1 mV/div and 2 mV/div to 40 MHz.

Optimum Signal Termination

For maximum measurement flexibility, switchable 50 Ω and 1 M Ω inputs are provided. The internal 50 Ω input with low reflections is useful for measurements requiring a 50 Ω termination for accurate pulse reproduction.

Serviceability

Innovations in circuit design along with custom integrated hybrid circuits reduce calibration time because of a minimum of adjustments. Wire harnesses and interconnection cables between boards are reduced with an interface board which connects the main boards together. This interface board helps to reduce service time and reassembly errors normally encountered with instruments containing many cables. These oscilloscopes, with the exception of the high writing speed 1744A, do not require a fan or ventilating holes for convection cooling which reduces the amount of dust and dirt that can accumulate internally.

Optional Measurement Capability

TV Sync Option (1740A, 1745A, 1746A)

With this option you can trigger on composite video for analysis of

fields, test signals, timing relationships, lines, or segments of lines. This capability is provided through a TV sync separator circuit that triggers the main sweep on the vertical interval of a composite video waveform and triggers the delayed sweep on individual horizontal lines.

Video Waveform Display

To aid in viewing specific portions of composite video waveforms, the TV sync option includes field select, TV line scan, and single line scan capabilities. Field selection is easily accomplished by pressing the Field Select button which automatically displays the alternate field in the frame. The TV Line Scan control allows you to position the intensified marker to the desired location for expansion. When switched to delayed sweep, individual lines are easily inspected and measured. For precise control of highly expanded line segments, single line scan lets you examine one line in detail.

The TV/Video Sync option is installed on the top cover and provides its own signal input with a 75 Ω termination to match most video systems. The input also provides a TV clamp which combines ac coupling and negative clamping to eliminate position shift due to varying levels for video information.

Three signal outputs on the back panel of the TV/Video Sync option provide access to the video signal, the main trigger signal, and the delayed trigger signal. These signals are routed to a vertical channel, the main trigger input, and the delayed trigger input to view video signals. The main and delayed trigger signals can also be used to sync other instruments on the video signal.

Optional Digital Multimeter (1740A, 1745A, 1746A)

Adding an optional 3½ digit autoranging DMM improves the convenience of your basic measurement capabilities. With the optional DMM, you can make the five most common measurements: ac and dc voltage, ac and dc current, and resistance. The DMM has autoranging so that readings always have the same multiplier: voltage in volts, current in amperes, and resistance in kilohms. In addition, the DMM has auto-zero which eliminates the need to zero the instrument prior to a test and auto-polarity for measuring either positive or negative voltages without reversing test leads.

In the 1746A, the optional DMM improves the accuracy and convenience of delta time measurements. A switch on the 1746A lets you select DMM operation or direct delta time readout.

- 200 cm/ μ s variable persistence & stored writing speed
- Minimum blind time, auto-intensity circuit
- Dual channel, 5 mV/div to 100 MHz
- 3rd channel trigger view and selectable input impedance

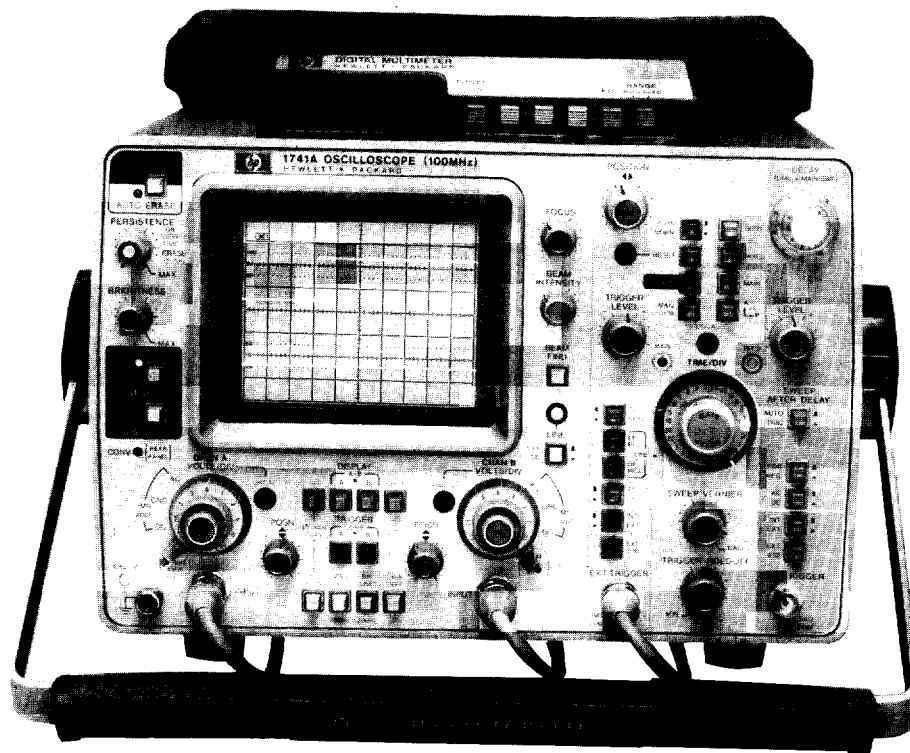

1741A Opt 034

1741A, 1744A Variable Persistence/Storage

Hewlett-Packard Variable Persistence/Storage Oscilloscopes provide a "one oscilloscope" solution to the wide variety of measurements encountered daily. The versatility results from the multitude of operating modes available; starting with minimum persistence, which approximates conventional operation, through continuous persistence settings, all the way to automatic storage. The adjustable persistence control provides the ability to match signal and persistence characteristics resulting in excellent display characteristics over a wide range of conditions.

Applications

These oscilloscopes provide a clear display of virtually any signal; however, they are especially useful in certain applications. Low repetition rate signals at fast sweep speeds produce very low light output on conventional CRTs and normally require the use of a viewing hood to obtain a viewable display. The variable persistence mode solves this problem by integrating several sweeps to amplify the light output, thereby producing bright, clear traces. This "light-integrating" capability is also useful in eliminating flickering displays, which are the result of low repetition rates and slow sweep speed signals. These signals are annoying to view and even more difficult to measure; however, the display is improved by matching signal and persistence characteristics.

Single-shot events are also captured easily by using the auto-store mode, which, once set, will wait and capture a sweep after the first trigger event. During operation of the oscilloscope, any display on the CRT can be saved at the touch of a button, no matter what mode the instrument is in.

Writing Speed and Blind Time

In all Hewlett-Packard storage oscilloscopes, the advanced technology used allows signals to be captured at the maximum writing speed in both variable persistence and single-shot modes (1741A-200 cm/ μ s; 1744A-1800 cm/ μ s; 1727A-2000 cm/ μ s). These fast writing

speeds are achieved without reduced scans or excessive blind times. Operating in the variable persistence mode, high speed signals can be displayed without the transfer or erase time (typically 1 second) necessary in other storage techniques. The probability of displaying a random event is increased by decreasing the blind time by a factor of 1000 or more in most situations.

A Comparison - Fast Writing Modes

1. HP's Variable Persistence Mode

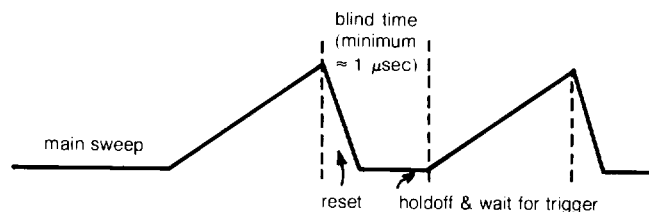

2. Transfer Techniques Not Used in HP Variable Persistence/Storage Oscilloscopes

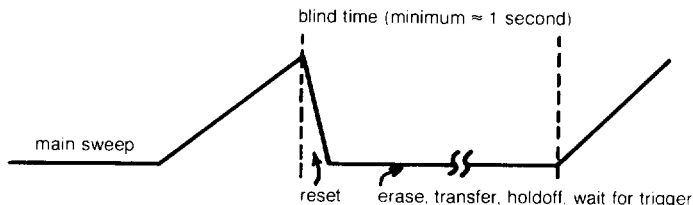

OSCILLOSCOPES

Variable Persistence/Storage

Models 1741A, 1744A, 1727A

- 1800 cm/ μ s (1744A) variable persistence & stored writing speed
- Minimum blind time, auto-intensity circuit
- Dual channel 5 mV/div to 100 MHz
- 3rd channel trigger view and selectable input impedance

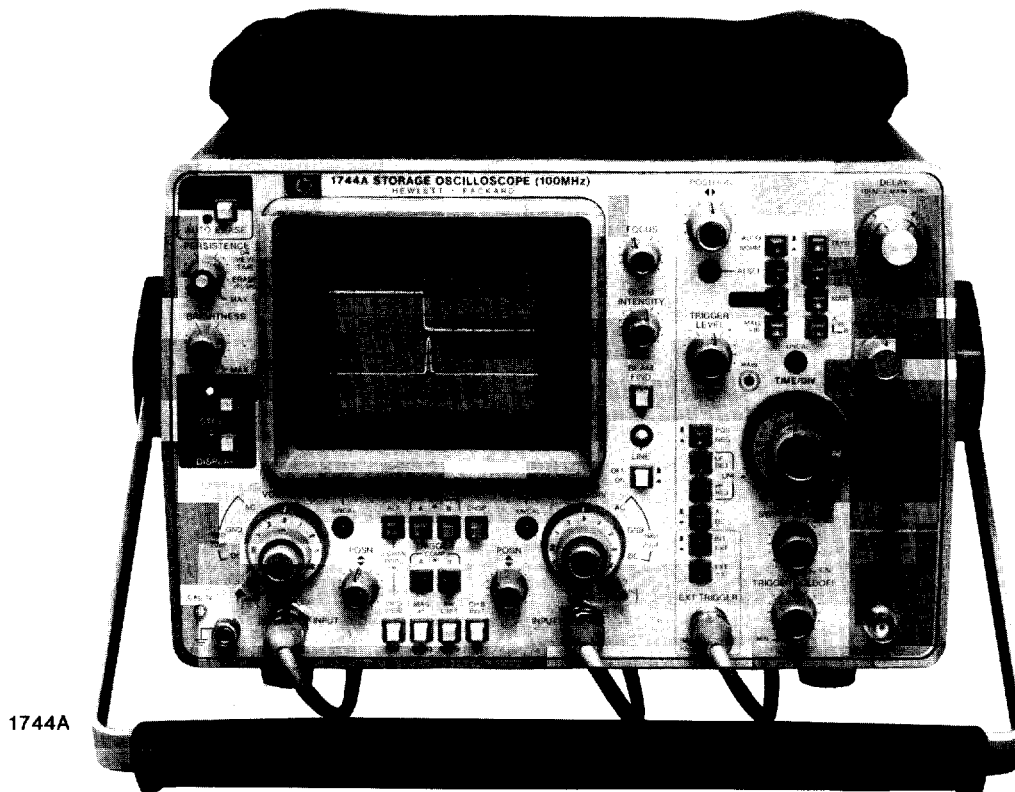

1744A

1741A, 1744A 1727A Operation

An auto-intensity circuit in all of these variable persistence/storage oscilloscopes simplifies operation. This circuit permits sharp, flicker-free, non-blooming traces to be obtained in the variable persistence mode under almost all operating conditions. There is a variety of settings available in the variable persistence mode; however, there is an easily set reference position that will provide a viewable trace: Intensity—max, Persistence—min, Brightness—min. From this position, Intensity can be decreased and Persistence can be increased as necessary.

In addition to the variable persistence mode, storage LEDs provide positive identification of storage operating modes. The auto-erase mode periodically takes individual "snapshots" of an input signal. In this mode, Persistence is internally set to maximum and the persistence control regulates how frequently a new "snapshot" is captured and displayed when two or more channels are displayed. The required number of sweeps are captured before a new cycle is initialized. This mode offers "hands-off" operation for probing circuits and a convenient method of quickly setting the focus and intensity for single-shot events.

The auto-store mode makes single-shot events easy to capture and reduces the possibility of recording the wrong event by automatically switching to the normal trigger mode. The oscilloscope automatically switches from a "write" mode to a

"store" mode after the sweep of the single-shot event for maximum trace retention time. A "store" LED indicates that the event is captured and one press of the Store/Display button displays the stored trace.

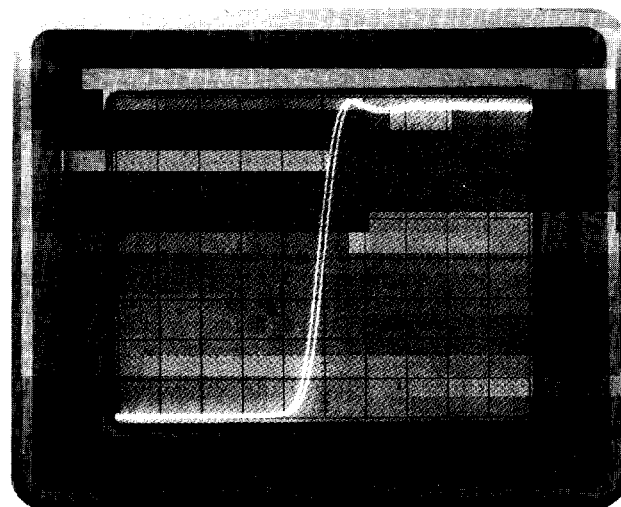
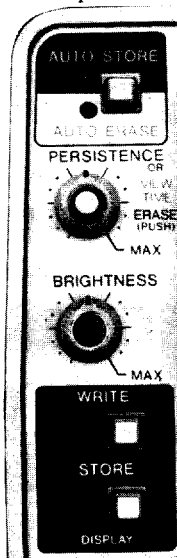

Exceptionally fine trace in the variable persistence mode permits high resolution timing measurements as shown with this dual trace, alternate sweep display at a sweep speed of 5 ns/div.

1741A Auto-Camera Option

The Auto-Camera Option 003 combines with Model 1741A to form a powerful method of obtaining photographic records, especially in long-term monitoring applications where hours of "babysitting" time can be saved. Setup involves mounting a Model 197B camera on the 1741A and selecting the auto-store mode. When the trigger signal is received, the oscilloscope sweeps and switches automatically to the store mode. Control circuits then command a display of the stored trace and actuate the camera shutter. After the first exposure of the waveform, the 1741A executes an erase cycle and, at the same time, the camera takes a second exposure to superimpose the graticule on the photograph.

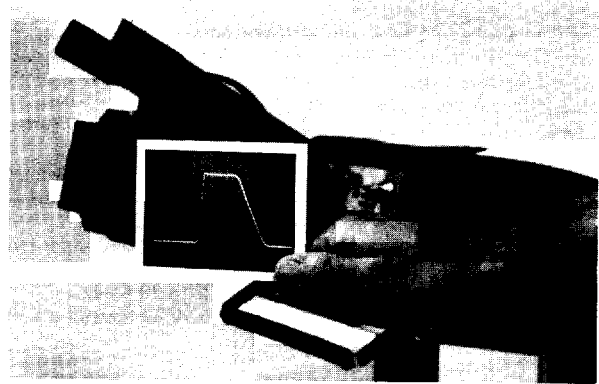

Long term monitoring of circuits to capture random events is simplified with the 1741A Auto-camera Option 003. You can set up the oscilloscope/camera, leave them unattended, and automatically capture single-shot events.

Optional Parametric Measurements

A new dimension of measurement capability is added to the 1741A with Option 002, triggered A vs B mode. Many non-time related displays commonly encountered in engineering problems, such as the Lissajous pattern, are clearly and accurately displayed. Option 002 adds a variable delay line in the horizontal axis which eliminates phase error and enables the 1741A to produce matched phase response up to the 5 MHz bandwidth of the horizontal section.

The display of parametric measurements is also enhanced by using main sweep to window several cycles of an event and then selecting delayed sweep, A vs B mode to examine each cycle. This triggered technique eliminates the bright spots caused by inactivity in the A vs B mode and removes any confusion created by having unnecessary information on the display.

Expansion Storage 1744A

The ability to capture signals at the maximum bandwidth of the 1744A vertical deflection system is achieved with expansion storage CRT technology. This fast writing speed is achieved by combining a miniature precision storage mesh with an electronic lens system that magnifies and projects the stored image. The storage mesh is about one-fifth the size of the viewing screen and is capable of storing sharp waveform images. An electron cloud from a flood gun projects the image through the electronic lens system into the CRT phosphor for viewing. The extremely fast writing speeds provided by the expansion mesh technology are available in both variable persistence and storage modes. Operation is enhanced with an automatic focus circuit and maintains a crisp display with changes in intensity while an auto-intensity circuit helps to maintain a constant beam current to the storage surface over a wide range of sweep speeds.

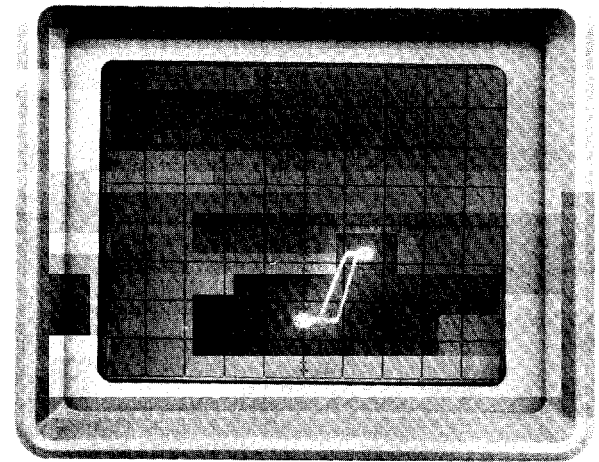

without triggered X, Y

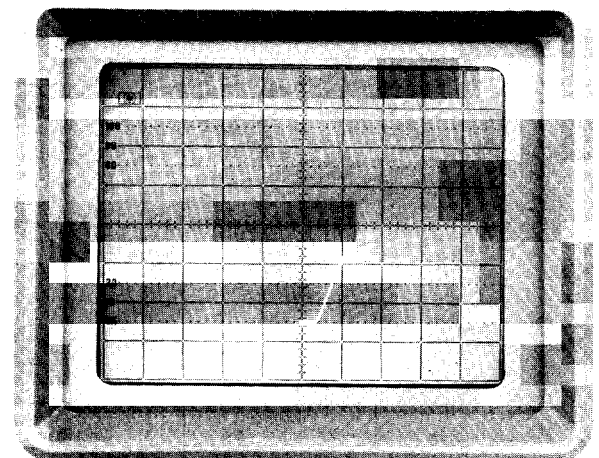
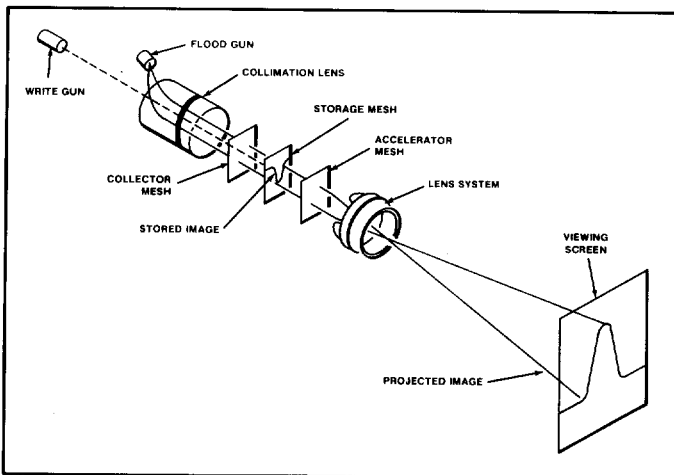

with triggered X, Y

Expansion Storage CRT

Expansion storage combines a miniature precision storage mesh with an electronic lens system that magnifies and projects the stored image.

1741A Triggered A vs B Option 002. The display of signals (top trace) in main sweep, A vs B mode shows total signal parameters. With delayed sweep A vs B, the display can be qualified (lower trace) to show only changing parameters which eliminates the bright dots caused by stationary values and confusion caused by unnecessary information.



OSCILLOSCOPES

Models 1740A, 1741A, 1743A, 1744A, 1745A, & 1746A (cont.)

1740A, 1741A, 1743A, 1744A, 1745A, 1746A Specifications

Vertical Display Modes

Channel A; channel B: A and B displayed alternately on successive sweeps (ALT); A and B displayed by switching between channels at ≈ 250 kHz rate with blanking during switching (CHOP); A plus B (algebraic addition); and trigger view.

Vertical Amplifiers (2) Bandwidth and rise time at all deflection factors from 0°C to +55°C.

Bandwidth: 3 dB down from 8 div reference signal; 3 dB down from 6 div reference signal for 1741A, 1744A; 3 dB down from 10 div reference signal for 1745A, 1746A.

DC-coupled: dc to 100 MHz in both 50 Ω and 1 M Ω input modes.

AC-coupled: ≈ 10 Hz to 100 MHz.

Bandwidth limit: limits upper bandwidth to ≈ 20 MHz.

Rise time: ≤ 3.5 ns measured from 10% to 90% points of a 6 div (5 div, 1744A, 1745A, 1746A) input step.

Deflection Factor

Ranges: 5 mV/div to 20 V/div (12 calibrated positions) in 1, 2, 5 sequence, attenuator accuracy $\pm 3\%$.

Vernier: extends deflection factor to ≥ 50 V/div.

Polarity: channel B may be inverted.

Input coupling: selectable ac or dc, 50 Ω (dc), or ground.

Input RC (selectable): ac or dc, 1 M Ω $\pm 2\%$ shunted by ≈ 20 pF; 50 Ω , 50 Ω $\pm 3\%$, SWR ≤ 1.4 at 100 MHz.

Maximum input: ac or dc, 250 V (dc + peak ac) or 500 V p-p at ≤ 1 kHz; 50 Ω , 5 V rms.

A + B Operation

Amplifier: bandwidth and deflection factors are unchanged; channel B may be inverted for A-B operation.

Differential (A-B) common mode: CMR is at least 20 dB from dc to 20 MHz. Common mode signal amplitude equivalent to 8 div (6 div, 1744A; 10 div for 1745A, 1746A) with one vernier adjusted for optimum rejection.

Vertical Magnification (X5)

Bandwidth: 3 dB down from 8 div (6 div, 1744A; 10 div for 1745A, 1746A) reference signal.

DC-coupled: dc to ≈ 40 MHz; dc to ≈ 30 MHz for 1741A, 1744A.

AC-coupled: ≈ 10 Hz to 40 MHz; ≈ 10 Hz to 30 MHz for 1741A, 1744A.

Rise time: ≤ 9 ns, ≤ 12 ns for 1741A, 1744A (measured from 10% to 90% points of 8 div, 5 div 1744A, 1745, 1746A input step).

Deflection factor: increases sensitivity of 5 and 10 mV settings by a factor of 5 with max sensitivity of 1 mV on channels A and B.

Trigger Source

Selectable from channel A, channel B, composite, or line frequency.

Trigger View

Displays internal or external trigger signal. In Alternate or Chop mode, channel A, channel B, and the trigger signals are displayed. In channel A or B mode, trigger view overrides that channel. Internal trigger signal amplitude approximates vertical signal amplitude. EXT trigger signal deflection factor is 100 mV/div or 1 V/div in EXT $\div 10$. Triggering point is approx center screen. With identically timed signals to a vertical input and the EXT trigger input, trigger signal delay is ≤ 3.5 ns.

Horizontal Display Modes

Main, Δ time with channel A or B start (1746A, 1743A), main intensified, mixed (except 1743A, 1746A), delayed, mag X10, and A vs. B.

Main and Delayed Time Bases

Ranges

Main: 50 ns/div to 2 s/div (24 ranges) in 1, 2, 5 sequence.

Delayed: 50 ns/div to 20 ms/div (18 ranges) in 1, 2, 5 sequence.

Accuracy

Sweep Time/div	*Accuracy		Temp Range
	X1	X10	
50 ns to 20 ms	$\pm 3\%$	$\pm 4\%$	0°C to +15°C
	$\pm 2\%$	$\pm 3\%$	+15°C to +35°C
	$\pm 3\%$	$\pm 4\%$	+35°C to +55°C

*Add 1% for 50 ms to 2 s ranges

Main sweep vernier: extends slowest sweep to at least 5 s/div.

Magnifier (X10): extends fastest sweep to 5 ns/div.

Calibrated Sweep Delay (except 1743A)

Delay time range: 0.5 to 10X Main Time/div settings of 100 ns to 2 s (min delay 150 ns).

Differential Time Measurement Accuracy

(Using one intensified marker and helidial control)

Main Time Base Setting	Accuracy* (+15°C to +35°C)
100 ns/div to 20 ms/div	$\pm(0.5\%$ of reading +0.1% of fs)
50 ms/div to 2 s/div	$\pm(1\%$ of reading +0.1% of fs)

*Add 1% for temperature from 0°C to +15°C and +35°C to +55°C.

Delay jitter: $<0.002\%$ (1 part in 50 000) of max delay in each step from +15°C to +35°C; $<0.005\%$ (1 part in 20 000) from 0°C to +15°C and +35°C to +50°C.

Differential Time Measurement Accuracy (1746A)

(Using Δ time dual intensified markers)

Main Time Base Setting	Accuracy* (+15°C to +35°C)		
	Opt 034/035	External DVM***	Helidial
100 ns** to 20 ms/div	$\pm(0.5\%$ of reading +0.05% of fs)	$\pm(0.5\%$ of reading +0.05% of fs)	$\pm(0.5\%$ of reading +0.1% of fs)
50 ms to 2 s/div	$\pm(1\%$ of reading +0.1% of fs)	$\pm(1\%$ of reading +0.1% of fs)	$\pm(1\%$ of reading +0.1% of fs)

*Add 1% for temperatures from 0°C to +15°C and +35°C to +55°C.

** On 100 ns/div range, specification applies after first cm of main sweep.

*** Add DVM accuracy.

Time Interval (Δ Time) 1746A

Function: measures time interval between two events on channel A (A display); two events on channel B (B display); or two events starting from an event on either channel A or B and ending with an event on either channel A or B (alternate display).

Time interval output voltage: varies from 50 V to 100 mV full scale. Full scale output voltage can be determined by multiplying the number on the Time/Div dial by 10 V (e.g., 0.05 s, 0.05 ms, or 0.05 μ s per div gives 0.5 V output full-scale).

Stability (0°C to +55°C): short-term 0.005%. Temperature, $\pm 0.03\%/^{\circ}\text{C}$ deviation from calibration temperature range.

Crystal Referenced Δ Time (1743A)

Delay time range: 0 to 10 X Main Time/Div settings of 100 ns to 2 s.

Differential time measurement accuracy

Accuracy: $\pm 0.002\%$ of reading ± 1 count from +15°C to +35°C; $\pm 0.005\%$ of reading ± 1 count from 0°C to +15°C and +35°C to +55°C.

Time Resolution of ± 1 Count

Sweep Ranges/div	± 1 Count	Averages
0.1 μ s, 0.2 μ s, 0.5 μ s	± 100 ps	10 000
1 μ s, 2 μ s, 5 μ s	± 1 ns	1 000
10 μ s, 20 μ s, 50 μ s	± 10 ns	100
0.1 ms, 0.2 ms, 0.5 ms	± 100 ns	direct

Readout: 5 digit LED plus exponent.

Crystal Aging: 0.0005% per year.

Delay jitter: same as other 1740 series oscilloscopes.

Triggering

Main Sweep

Normal: sweep is triggered by internal or external signal.

Automatic: baseline displayed in absence of input signal. Above ≈ 40 Hz, triggering is same as normal.

Single: sweep occurs once with same triggering as Normal. Reset arms sweep and lights indicator (1741A, 1744A). Single sweep is also initiated with Erase, sweep is armed after the erase cycle.

Internal: dc to 25 MHz on signals ≥ 0.3 div vertical deflection, increasing to 1 div vertical deflection at 100 MHz in all display modes (required signal level is increased by 2 when in Chop mode and by 5 when X5 vertical magnifier is used).

External: dc to 50 MHz on signals of 50 mV p-p or more, increasing to 100 mV p-p at 100 MHz (required signal level is increased by 2 when in Chop mode).

Delayed Sweep (Sweep After Delay)

Auto: delayed sweep starts at end of delay period.

Trig: delayed sweep armed and triggerable at end of delay period. **Internal:** same as Main Sweep except 1743A is dc to 25 MHz on signals causing 1 div or more vertical deflection, increasing to 2 div of vertical deflection at 100 MHz.

External: same as Main sweep except 1743A is dc to 50 MHz on signals 100 mV p-p increasing to 200 mV p-p at 100 MHz.



External input RC: $\approx 1 \text{ M}\Omega$ shunted by $\approx 20 \text{ pF}$; max external input, 250 V (dc + peak ac) or 500 V p-p at $\leq 1 \text{ kHz}$.

Level and slope: internal, at any point on positive or negative slope of displayed waveform; external, continuously variable from +1 V to -1 V on either slope of trigger signal, +10 V to -10 V in $\div 10$.

Coupling: ac, dc, LF REJ, or HF REJ.

Trigger holdoff (main sweep): increases sweep holdoff, all ranges.

Calibrated Mixed Time Base (except 1743A, 1746A)

Dual time base in which the main time base drives the first portion of sweep and the delayed time base completes the sweep at the faster delayed sweep. Also operates in single sweep mode. Accuracy, add 2% to main time base accuracy.

A vs B Operation

Bandwidth: channel A (Y-axis), same as channel A; channel B (X-axis), dc to 5 MHz.

Deflection factor: 5 mV/div to 20 V/div (12 cal positions) in 1, 2, 5 sequence; phase difference between channels, $< 3^\circ$, dc to 100 kHz (75 kHz, 1743A).

Cathode Ray Tube and Controls (1740A, 1743A)

Type: 12.7 cm (5 in.) rectangular CRT, post accelerator, $\approx 15 \text{ kV}$ accelerating potential, aluminized P31 phosphor.

Graticule: 8×10 div (1 div = 1 cm) internal nonparallax graticule, 0.2 subdivision markings on major horizontal and vertical axes and markings for transition time measurements. Internal floodgun graticule illumination.

Beam finder: returns trace to CRT screen.

Z-axis input (intensity modulation): +4 V, $\geq 50 \text{ ns}$ wide pulse blanks trace of any intensity, usable to $\leq 10 \text{ MHz}$ for normal intensity. Input R, $1 \text{ k}\Omega \pm 10\%$. Max input $\pm 20 \text{ V}$ (dc + peak ac).

Rear panel controls: astigmatism and trace align.

Cathode Ray Tube and Controls (1745A, 1746A)

Type: Hewlett-Packard, 15.6 cm (6.15 in.) rectangular CRT, post accelerator, approximately 21 kV accelerating potential, aluminized P31 phosphor.

Graticule: 10×10 div; 1 vertical div = 0.95 cm, 1 horizontal div = 1.2 cm; internal nonparallax graticule with 0.2 subdivision markings on major horizontal and vertical axes, markings for rise time measurements. Internal flood gun graticule illumination.

Beam finder: returns trace to CRT regardless of horizontal, vertical, or intensity settings.

Z-axis input (intensity modulation): +4 V, $> 50 \text{ ns}$ width pulse blanks trace of any intensity, usable to $\leq 10 \text{ MHz}$ for normal intensity; input R, $1 \text{ k}\Omega \pm 10\%$; maximum input $\pm 20 \text{ V}$ (dc + peak ac), $\leq 1 \text{ kHz}$.

Rear panel controls: astigmatism and trace align.

Cathode Ray Tube and Controls (1741A)

Type: 12.7 cm (5 in.) rectangular CRT, post accelerator, $\approx 7.5 \text{ kV}$ accelerating potential, aluminized P31 phosphor.

Graticule: 8×10 div (1 div = 0.85 cm) internal, nonparallax graticule, 0.2 subdivision markings on major horizontal and vertical axes, with markings for transition time measurements. Graticule illumination is achieved with Persistence control set to min.

Beam finder: returns trace to CRT screen.

Z-axis input (intensity modulation): same as 1740A.

Operating modes: write, store, display, auto-store, auto-erase, and conventional (rear panel control).

Persistence: variable, $\approx 100 \text{ ms}$ to 1 min; conventional, $\approx 40 \mu\text{s}$.

Writing speed, variable persistence and storage: $\geq 200 \text{ cm}/\mu\text{s}$ (235 div/ μs) over center 7×9 div (with viewing hood).

Storage time: display mode, at least 10 s at 22°C ; store mode, at least 30 s at 22°C .

Brightness: $\approx 170 \text{ cd}/\text{m}^2$ (50 fl) increasing to $\approx 340 \text{ cd}/\text{m}^2$ (100 fl) depending on brightness control setting.

Erase time: $\approx 300 \text{ ms}$.

Rear panel controls: astigmatism, trace align, conventional push-button, and view time.

Cathode Ray Tube and Controls (1744A)

Type: 12.7 cm (5 in.) rectangular CRT, post accelerator, $\approx 10 \text{ kV}$ accelerating potential, aluminized P31 phosphor.

Graticule: 8×10 div (1 div = 0.72 cm) internal graticule, 0.2 subdivision markings on major horizontal and vertical axes, with markings for transition time measurements. Graticule illumination is achieved with Persistence control set to min.

Beam finder, Z-axis input (intensity modulation): See 1740A.

Operating modes: write, store, display, auto-store, and auto-erase.

Writing speed, variable persistence and storage: $\geq 1800 \text{ cm}/\mu\text{s}$ (2500 div/ μs) over center 6×8 div (with viewing hood).

Storage time: store mode, at least 30 s; view mode, at least 10 s; wait time, at least 60 s, at 22°C .

Persistence: variable (100 ms min).

Erase time: $\approx 300 \text{ ms}$.

Rear panel controls: astigmatism and trace align.

General

Rear panel outputs: main and delayed gates, 0.8 V to $\geq +2.5 \text{ V}$ capable of supplying $\approx 5 \text{ mA}$.

Amplitude Calibrator (0°C to $+55^\circ\text{C}$)

Output Voltage: 1 V p-p into $\geq 1 \text{ M}\Omega$, 0.1 V p-p into 50Ω ; accuracy, $\pm 1\%$.

Rise time: $\approx 0.1 \mu\text{s}$.

Frequency: $\approx 1.4 \text{ kHz}$.

Power: 100, 120, 220, 240 V ac $\pm 10\%$; 48 to 440 Hz; 100 VA max.

Weight: (1740) net, 13 kg (28.6 lb); shipping 15.7 kg (34.6 lb). (1741, 1743, 1744) net 13.8 kg (30.5 lb); shipping 17.7 kg (39 lb).

Operating environment: temperature 0°C to $+55^\circ\text{C}$; humidity to 95% relative humidity at $+40^\circ\text{C}$; altitude, to 4600 m (15,000 ft); vibration, vibrated in three planes for 15 min. each with 0.254 mm (0.010 in.) excursion, 10 to 55 Hz.

Size: (1740A, 1745A) 197 H x 335 W x 597 mm D (7.8" x 13.2" x 23.5") with handle, 492 mm D (19.4 in.) without; (1741A) 616 mm D (24.3 in.) with handle, 552 mm D (21.7 in.) without; (1746A) 570 mm D (22.4 in.) with handle, 502 mm D (19.8 in.) without; (1743A) 613 mm D (24.1 in.) with handle, 549 mm D (21.6 in.) without; (1744A) 635 mm D (25 in.) with handle; 511 mm D (20.1 in.) without.

Accessories furnished: one blue light filter HP P/N 01740-02701, one front panel cover, one 2.3 m (7.5 ft) power cord, one vinyl accessory storage pouch, one Operators Guide and one Service Manual, two Model 10041A 10:1 divider probes $\approx 2 \text{ m}$ (6.6 ft) long. The 1741A and 1744A also include one Model 10173A RFI filter and contrast screen, and one Model 10140A viewing hood.

Options and Accessories

001: fixed power cord (U.S. only). Price add \$15

002 (1741A): Triggered A vs B Mode; phase shift $\leq 2^\circ$, dc to 5 MHz; internal triggering on channel B. Price add \$225

003: Auto Camera (1741A) Price add \$75

005 (except 1743A, 1744): TV sync Price add \$330

034 (except 1743A, 1744A): built-in DMM (60 Hz) Price add \$430

035 (except 1743A, 1744A): built-in DMM (50 Hz) Price add \$430

091: two 3 m (9.8 ft) 10042A 10:1 probes in lieu of 10041A probes Price N/C

096: two 1.8 m (6 ft) 10006D 10:1 probes in lieu of 10041A probes. Price N/C

112: includes 1112A Inverter Power Supply, a portable power source for 1700 series oscilloscopes. Price add \$1525

910: extra set of product manuals. Price add \$30

Multimeter kit: HP P/N 01742-69501 (1746A), 01741-69502 (1741A), or 01740-69503 (1740A, 1745A) adapts standard oscilloscope to an Option 034/035 with built-in LED readout. Kit includes a multimeter, top oscilloscope cover, vinyl storage pouch, and mounting hardware. Price \$450