

Agilent 2-Port PNA-L Microwave Network Analyzer

N5230A
300 kHz to 6, 13.5 GHz
10 MHz to 20, 40, 50 GHz

Data Sheet

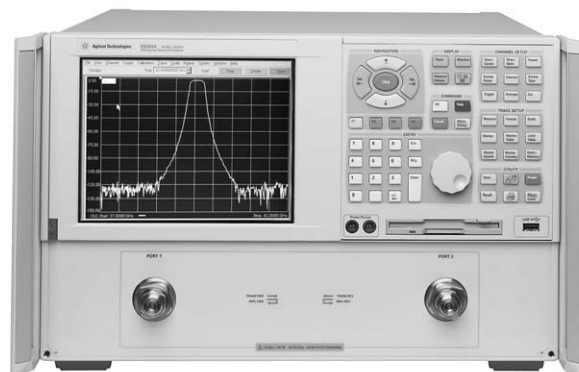
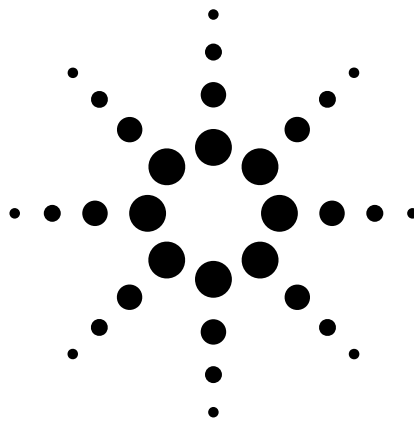

Note:
Specification information in this document is also available within the PNA-L network analyzer's internal Help system.

Table of Contents

Definitions	3
Corrected System Performance	4
Table 1. System dynamic range	4
Table 2. Extended dynamic range	5
N5230A Corrected system performance with 3.5mm connectors	6
Table 3. 85052B Calibration kit N5230A – Configuration test set and extended power range (Option 025 or 125) ..	6
Table 4. 85052B Calibration kit N5230A – Configuration test set and extended power range (Option 225) ...	8
Table 5. N4691A Electronic calibration module N5230A – Configuration test set and extended power range (Option 225) ...	10
Table 6. 85056A Calibration kit N5230A – Configuration test set and extended power range (Option 425 or 525)	12
Table 7. N4693A Electronic calibration module N5230A – Configuration test set and extended power range (Option 425 or 525)	14
N5230A Corrected system performance with Type-N connectors	16
Table 8. N5232B Calibration kit N5230A – Configuration test set and extended power range (Option 025)	16
Table 9. Uncorrected system performance	18
Table 10. Test port output	19
Table 11. Test port input	21
Dynamic Accuracy	25
Table 12. Test port input (group delay)	31
General Information	32
Table 13. Miscellaneous information	32
Table 14. Front panel information	32
Table 15. Rear panel information	33
Table 16. Analyzer environment and dimensions	34
Measurement Throughput Summary	35
Table 17. Typical cycle time (ms) for measurement completion	35
Table 18. Cycle time vs IF bandwidth (Options 020, 025, 120, 125) ...	36
Table 19. Cycle time vs IF bandwidth (Options 220, 225, 420, 425) ...	37
Table 20. Cycle time vs number of points (Options 020, 025, 120, 125) ...	38
Table 21. Cycle time vs number of points (Options 220, 225, 420, 425, 520, 525)	37
Table 22. Data transfer time (ms)	39
Specifications: Front-Panel Jumpers	40
Table 23: Measurement receiver inputs (Rcvr A In, Rcvr B In)	40
Table 24: Reference receiver inputs (Rcvr R1, Rcvr R2)	41
Table 25: Reference outputs (Reference 1 Source out, Reference 2 Source Out)	41
Table 26: Source outputs (Port 1 source out, Port 2 Source Out)	42
Table 27: Coupler inputs (port 1 Cplr Thru, Port 2 Cplr Thru)	42
Table 28: Coupler outputs (port 1 Cplr Arm, Port 2 Cplr Arm)	42
Test Set Block Diagrams	43
N5230A Option 220, or 420, or 520 (standard test set and standard power range) network analyzer ...	43
N5230A Option 225, or 425, or 525 (configurable test set and extended power range) network analyzer .	43

This is a subset of technical specifications for the N5230A network analyzer.

To view or print the N5230A technical specifications, visit our web site at www.agilent.com/find/pnal

This N5230A document provides technical specifications for the following calibration kits and ECal modules only: 85052B, 85056A, 85032B, N4691A, and N4693A. Please download our free Uncertainty Calculator from www.agilent.com/find/na_calculator to generate the curves for your calibration kit and PNA setup.

Definitions

All specifications and characteristics apply over a 25 °C \pm 5 °C range (unless otherwise stated) and 90 minutes after the instrument has been turned on.

Specification (spec.): Warranted performance. Specifications include guardbands to account for the expected statistical performance distribution, measurement uncertainties, and changes in performance due to environmental conditions.

Characteristic (char.): A performance parameter that the product is expected to meet before it leaves the factory, but that is not verified in the field and is not covered by the product warranty. A characteristic includes the same guardbands as a specification.

Typical (typ.): Expected performance of an average unit which does not include guardbands. It is not covered by the product warranty.

Nominal (nom.): A general, descriptive term that does not imply a level of performance. It is not covered by the product warranty.

Calibration: The process of measuring known standards to characterize a network analyzer's systematic (repeatable) errors.

Corrected (residual): Indicates performance after error correction (calibration). It is determined by the quality of calibration standards and how well "known" they are, plus system repeatability, stability, and noise.

Uncorrected (raw): Indicates instrument performance without error correction. The uncorrected performance affects the stability of a calibration.

Standard: When referring to the analyzer, this includes no options unless noted otherwise.

Corrected System Performance

The specifications in this section apply for measurements made with the N5230A analyzer with the following conditions:

- 10 Hz IF bandwidth
- No averaging applied to data
- Isolation calibration with an averaging factor of 8

Table 1. System dynamic range¹

Standard configuration and standard power range

Description	Specification (dB) at test port				Typical (dB) at test port			
	Option 020, 120	Option 220	Option 420	Option 520	Option 020, 120	Option 220	Option 420	Option 520
300 kHz to 1 MHz	103							
1 MHz to 10 MHz	113							
10 MHz to 45 MHz	122				103	89	89	
45 MHz to 70 MHz ²	122	101	90	90				
70 MHz to 500 MHz ²	122	105	90	90				
500 MHz to 2 GHz	122	110	110	110				
2 GHz to 6 GHz	122	110	110	110				
6 GHz to 8 GHz	120	110	110	110				
8 GHz to 9 GHz	120	110	100	100				
9 GHz to 10.5 GHz	116	110	100	100				
10.5 GHz to 12.5 GHz	111	110	100	100				
12.5 GHz to 13.5 GHz	109	108	100	100				
13.5 GHz to 20 GHz		108	100	100				
20 GHz to 31.25 GHz			95	95				
31.25 GHz to 40 GHz			90	90				
40 GHz to 50 GHz				79				

Configurable test set and extended power range

Description	Specification (dB) at test port				Typical (dB) at test port			
	Option 025, 125	Option 225	Option 425	Option 525	Option 025, 125	Option 225	Option 425	Option 525
300 kHz to 1 MHz	102							
1 MHz to 10 MHz	112							
10 MHz to 45 MHz	121				103	88	88	
45 MHz to 70 MHz ²	121	101	90	90				
70 MHz to 500 MHz ²	121	105	90	90				
500 MHz to 2 GHz	121	110	110	110				
2 GHz to 6 GHz	121	110	110	110				
6 GHz to 8 GHz	120	110	110	110				
8 GHz to 9 GHz	120	110	100	100				
9 GHz to 10.5 GHz	116	110	100	100				
10.5 GHz to 12.5 GHz	111	110	100	100				
12.5 GHz to 13.5 GHz	108	108	100	100				
13.5 GHz to 20 GHz		108	100	100				
20 GHz to 31.25 GHz			92	92				
31.25 GHz to 40 GHz			87	87				
40 GHz to 50 GHz				75				

1. The system dynamic range is calculated as the difference between the noise floor and the specified source maximum output power. The effective dynamic range must take measurement uncertainties and interfering signals into account.
2. May be degraded by 10 dB at particular frequencies (multiples of 5 MHz) below 500 MHz due to spurious receiver residuals. Methods are available to regain the full dynamic range.

Table 2. Extended dynamic range¹

Configurable test set and extended power range

Description	Specification (dB) at direct receiver access input				Typical (dB) at direct receiver access input			
	Option 025, 125	Option 225	Option 425	Option 525	Option 025, 125	Option 225	Option 425	Option 525
300 kHz to 1 MHz	118							
1 MHz to 10 MHz	128							
10 MHz to 45 MHz	137				115	109	109	
45 MHz to 70 MHz ²	137	113	111	111				
70 MHz to 500 MHz ²	137	117	111	111				
500 MHz to 2 GHz	137	122	122	122				
2 GHz to 6 GHz	137							
6 GHz to 8 GHz	136	122	122	122				
8 GHz to 9 GHz	136							
9 GHz to 10.5 GHz	132	122	112	112				
10.5 GHz to 12.5 GHz	127	122	112	112				
12.5 GHz to 13.5 GHz	124	120	112	112				
13.5 GHz to 20 GHz	120		112	112				
20 GHz to 31.25 GHz				103	103			
31.25 GHz to 40 GHz				98	98			
40 GHz to 50 GHz					83			

1. The direct receiver access input extended dynamic range is calculated as the difference between the direct receiver access input noise floor and the source maximum output power. The effective dynamic range must take measurement uncertainties and interfering signals into account. This set-up should only be used when the receiver input will never exceed its compression or damage level. When the analyzer is in segment sweep mode, it can have predefined frequency segments which will output a higher power level when the extended dynamic range is required (i.e. devices with high insertion loss), and reduced power when receiver compression or damage may occur (i.e. devices with low insertion loss). The extended range is only available in one-path transmission measurements.
2. May be degraded by 10 dB at particular frequencies (multiples of 5 MHz) below 500 MHz due to spurious receiver residuals. Methods are available to regain the full dynamic range.

N5230A Corrected system performance with 3.5 mm connectors

Table 3. 85052B Calibration kit

N5230A – configurable test set and extended power range (Option 025, 125)

Configurable test set, extended power range

Applies to the N5230A Option 025.125 analyzers, 85052B (3.5 mm) calibration kit, 85131F flexible test port cable set, and a full 2-port calibration. Also applies to the following condition: Environmental temperature $23^{\circ} \pm 3^{\circ} \text{C}$, with $< 1^{\circ} \text{C}$ deviation from calibration temperature.

Description	Specification (dB)			
	300 kHz to 10 MHz	10 MHz to 2 GHz	2 to 8 GHz	8 to 13.5 GHz
Directivity	48	48	44	44
Source match	40	40	33	31
Load match	48	48	44	44
Reflection tracking	± 0.003 (+0.02/°C)	± 0.003 (+0.02/°C)	± 0.003 (+0.03/°C)	± 0.006 (+0.03/°C)
Transmission tracking	± 0.017 (+0.02/°C)	± 0.015 (+0.02/°C)	± 0.075 (+0.03/°C)	± 0.131 (+0.03/°C)

Transmission uncertainty (specifications)

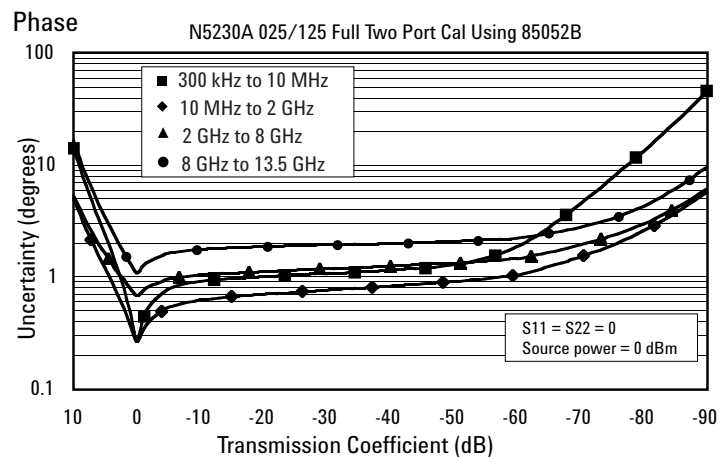
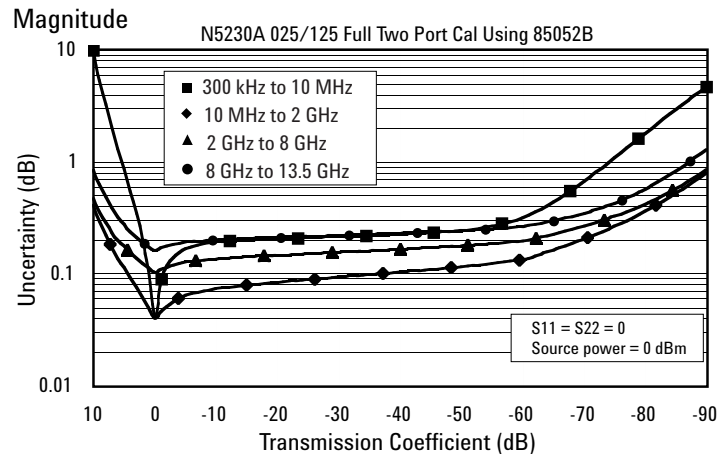

Reflection uncertainty (specifications)

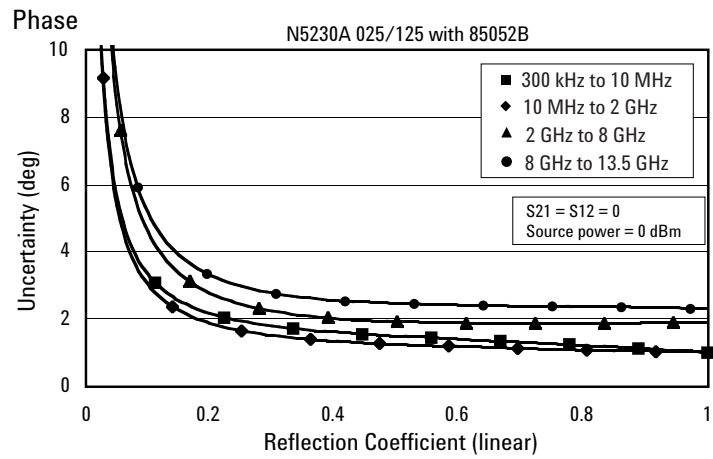
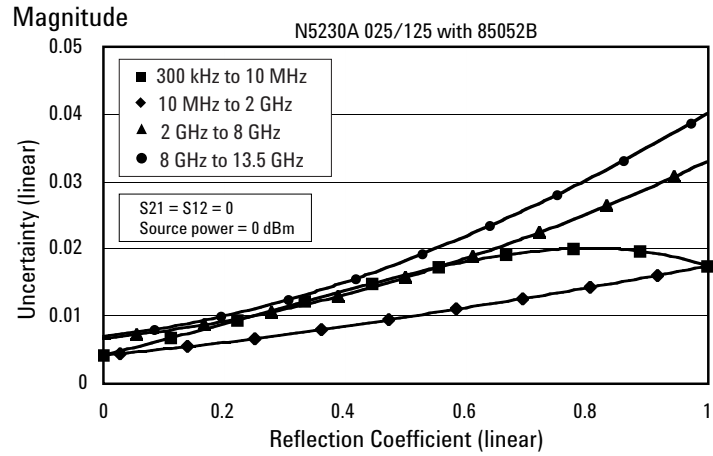

N5230A Corrected system performance with 3.5 mm connectors

Table 4. 85052B Calibration kit
N5230A – configurable test set and extended power range (Option 225)

Configurable test set, extended power range

Applies to the N5230A Option 225 analyzers, 85052B (3.5mm) calibration kit, 85131F flexible test port cable set, and a full 2-port calibration. Also applies to the following condition: Environmental temperature 23° ±3 °C, with < 1 °C deviation from calibration temperature.

Description	Specification (dB)			
	45 MHz to 500 MHz	500 MHz to 2 GHz	2 to 8 GHz	8 to 20 GHz
Directivity	48	48	44	44
Source match	40	40	33	31
Load match	48	48	44	44
Reflection tracking	±0.003 (+0.02/°C)	±0.003 (+0.02/°C)	±0.003 (+0.03/°C)	±0.006 (+0.03/°C)
Transmission tracking	±0.010 (+0.02/°C)	±0.014 (+0.02/°C)	±0.062 (+0.03/°C)	±0.104 (+0.03/°C)

Transmission uncertainty (specifications)

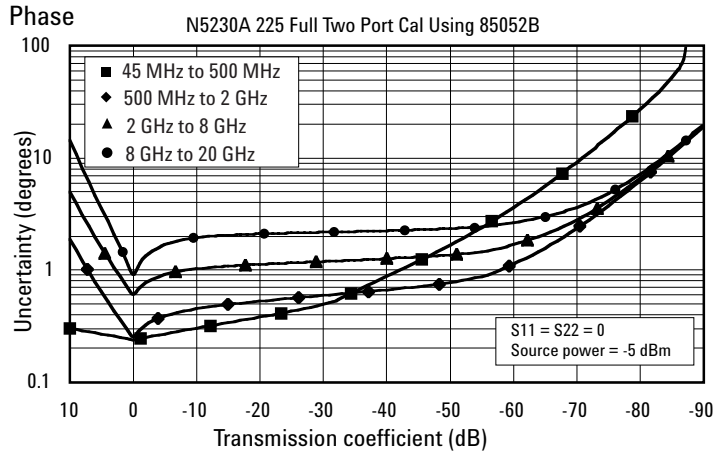
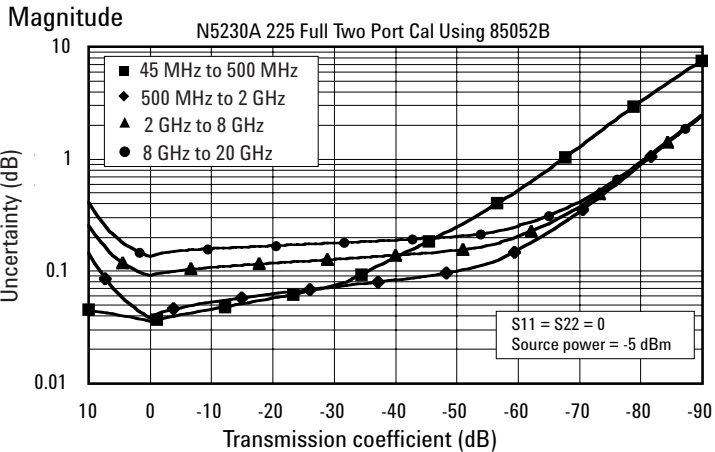

N4691A Electronic calibration module
N5230A – configurable test set and extended power range (Option 225)

Reflection uncertainty (specifications)

Magnitude

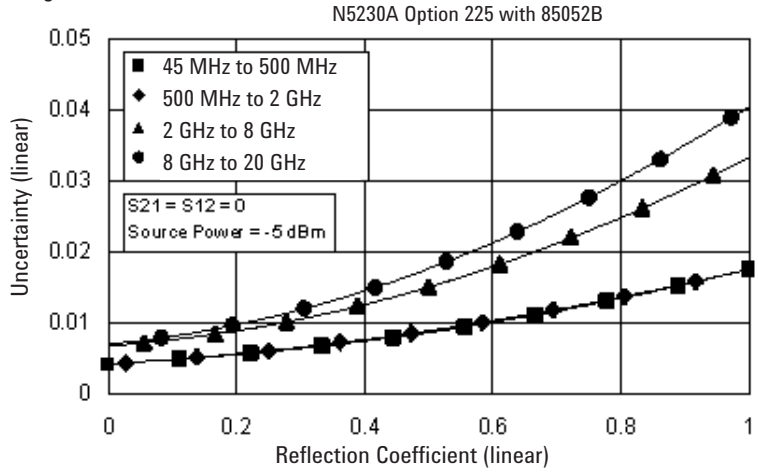

Phase

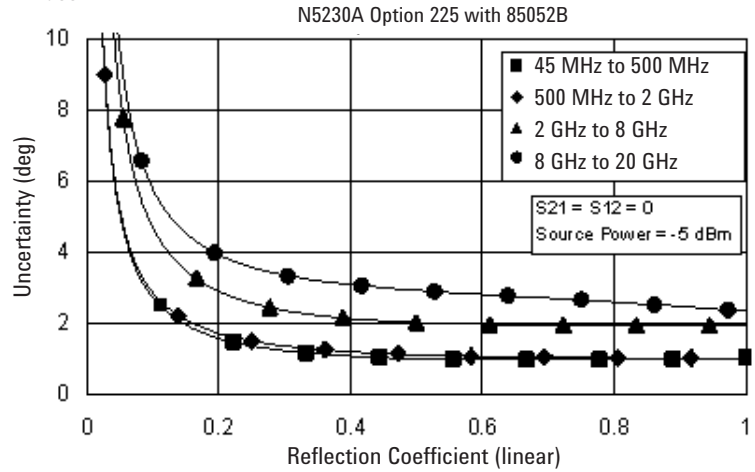

N5230A Corrected system performance with 3.5 mm connectors

Table 5. N4691A Electronic calibration module
N5230A – configurable test set and extended power range (Option 225)

Configurable test set, extended power range

Applies to the N5230A Option 225 analyzers, N4691A electronic calibration module, 85131F flexible test port cable set, and a full 2-port calibration. Also applies to the following condition: Environmental temperature $23^{\circ} \pm 3^{\circ} \text{C}$, with $< 1^{\circ} \text{C}$ deviation from calibration temperature.

Description	Specification (dB)			
	45 MHz to 500 MHz	500 MHz to 2 GHz	2 to 8 GHz	8 to 20 GHz
Directivity	56	56	54	49
Source match	47	47	45	44
Load match	46	46	42	40
Reflection tracking	± 0.050 (+0.02/ $^{\circ}\text{C}$)	± 0.050 (+0.02/ $^{\circ}\text{C}$)	± 0.070 (+0.03/ $^{\circ}\text{C}$)	± 0.090 (+0.03/ $^{\circ}\text{C}$)
Transmission tracking	± 0.051 (+0.02/ $^{\circ}\text{C}$)	± 0.051 (+0.02/ $^{\circ}\text{C}$)	± 0.074 (+0.03/ $^{\circ}\text{C}$)	± 0.101 (+0.03/ $^{\circ}\text{C}$)

Transmission uncertainty (specifications)

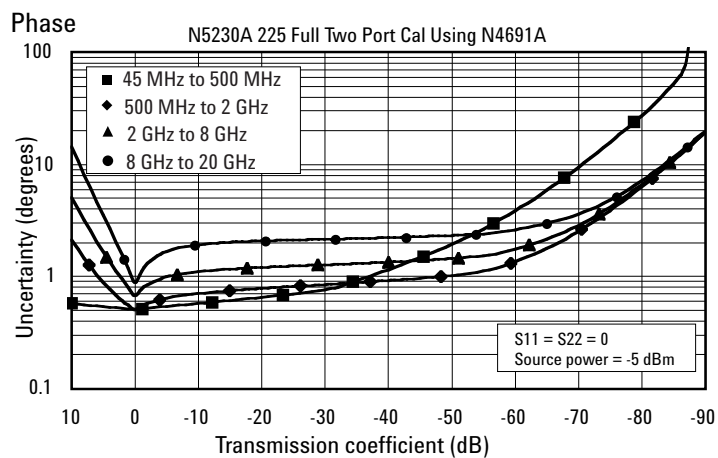
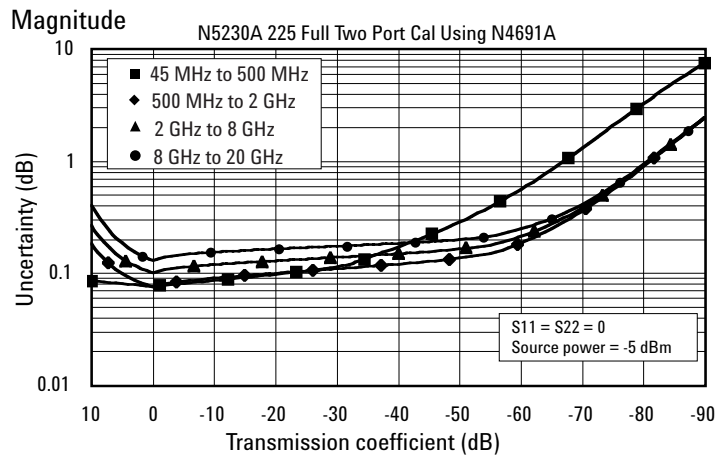

N4691A Electronic calibration module
N5230A – configurable test set and extended power range (Option 225)

Reflection uncertainty (specifications)

Magnitude

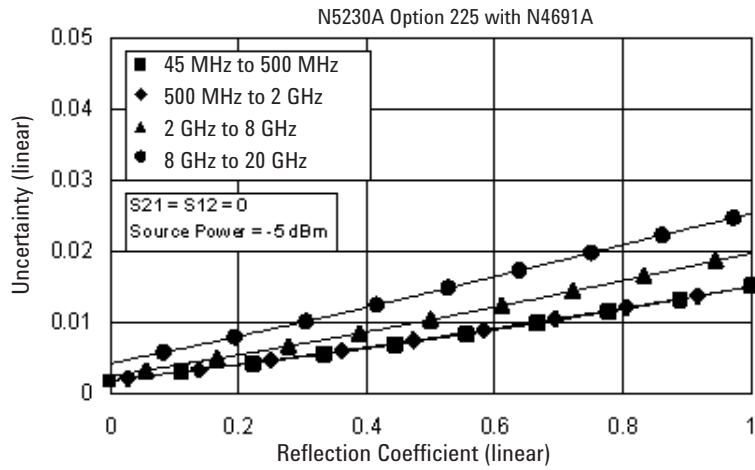

Phase

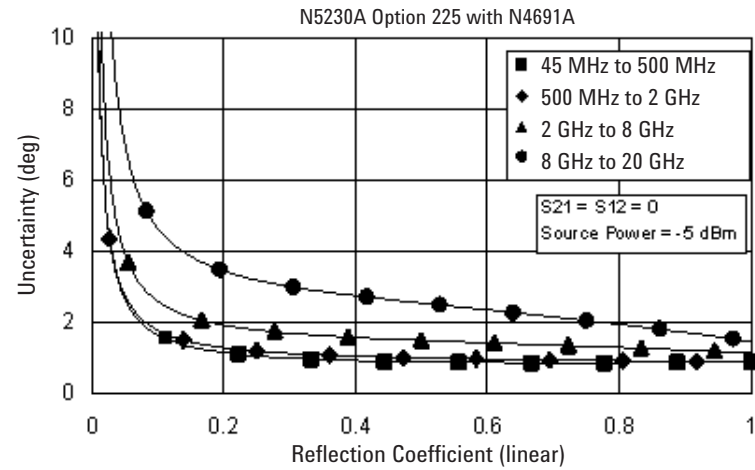

N5230A Corrected system performance with 2.4 mm connectors

Table 6. 85056A Calibration kit
N5230A – configurable test set and extended power range (Option 425 or 525)

Configurable test set, extended power range

Applies to the N5230A Option 425 or 525 analyzers, 85056A (2.4 mm) electronic calibration module, 85133F flexible test port cable set, and a full 2-port calibration. Also applies to the following condition: Environmental temperature $23^\circ \pm 3^\circ \text{C}$, with $< 1^\circ \text{C}$ deviation from calibration temperature.

Description	Specification (dB)			
	45 MHz to 2 GHz	2 to 20 GHz	20 to 40 GHz	40 to 50 GHz
Directivity	42	42	38	36
Source match	41	38	33	31
Load match	42	42	37	35
Reflection tracking	± 0.001 (+0.02/ $^\circ\text{C}$)	± 0.008 (+0.02/ $^\circ\text{C}$)	± 0.020 (+0.02/ $^\circ\text{C}$)	± 0.027 (+0.03/ $^\circ\text{C}$)
Transmission tracking	± 0.019 (+0.02/ $^\circ\text{C}$)	± 0.057 (+0.02/ $^\circ\text{C}$)	± 0.124 (+0.02/ $^\circ\text{C}$)	± 0.211 (+0.03/ $^\circ\text{C}$)

Transmission uncertainty (specifications)

Magnitude

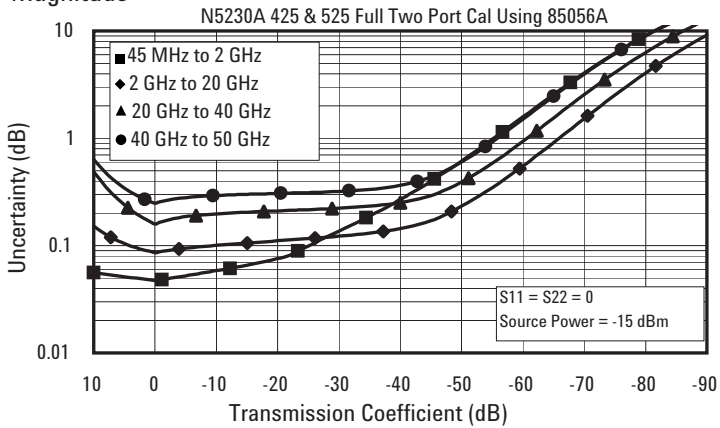

Phase

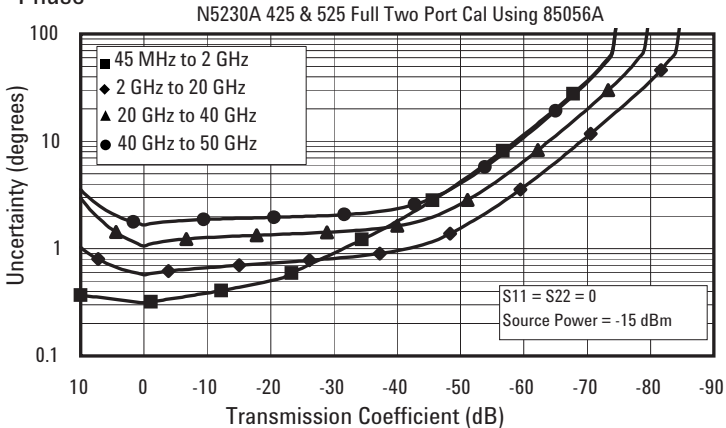

Reflection uncertainty (specifications)

Magnitude

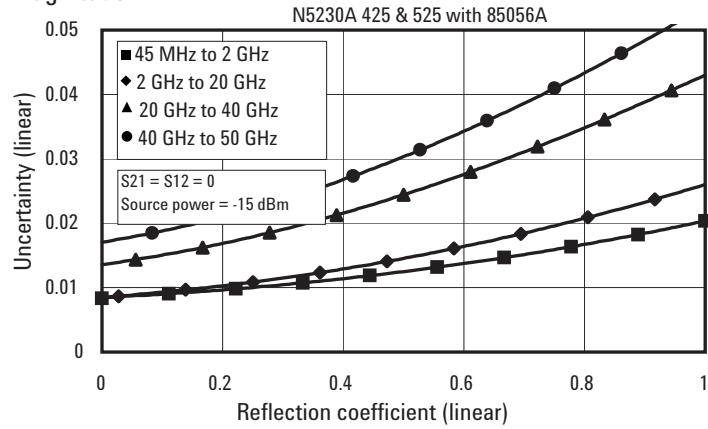

Phase

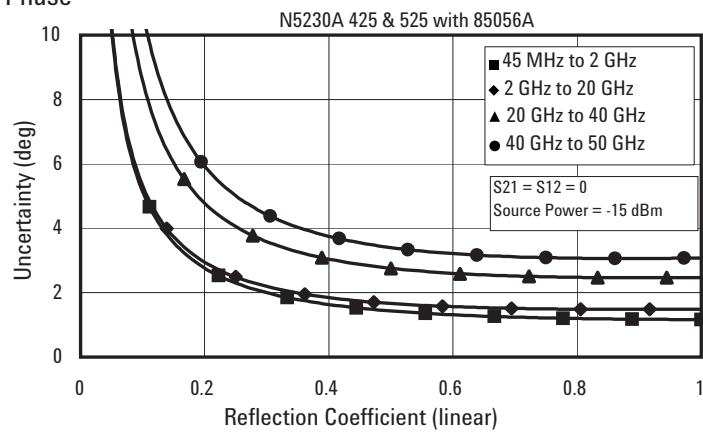

**Table 7. N4693A Electronic calibration module
N5230A – configurable test set and extended power range (Option 425 or 525)**

Configurable test set, extended power range

Applies to the N5230A Option 425 or 525 analyzers, N4693A (2.4 mm) electronic calibration module, 85133F flexible test port cable set, and a full 2-port calibration. Also applies to the following condition: Environmental temperature $23^{\circ} \pm 3^{\circ} \text{C}$, with $< 1^{\circ} \text{C}$ deviation from calibration temperature

Description	Specification (dB)			
	45 MHz to 2 GHz	2 to 20 GHz	20 to 40 GHz	40 to 50 GHz
Directivity	55	49	43	41
Source match	46	42	35	30
Load match	43	41	37	36
Reflection tracking	± 0.030 ($+0.02/^{\circ}\text{C}$)	± 0.040 ($+0.02/^{\circ}\text{C}$)	± 0.060 ($+0.02/^{\circ}\text{C}$)	± 0.080 ($+0.03/^{\circ}\text{C}$)
Transmission tracking	± 0.056 ($+0.02/^{\circ}\text{C}$)	± 0.078 ($+0.02/^{\circ}\text{C}$)	± 0.107 ($+0.02/^{\circ}\text{C}$)	± 0.130 ($+0.03/^{\circ}\text{C}$)

Transmission uncertainty (specifications)

Magnitude

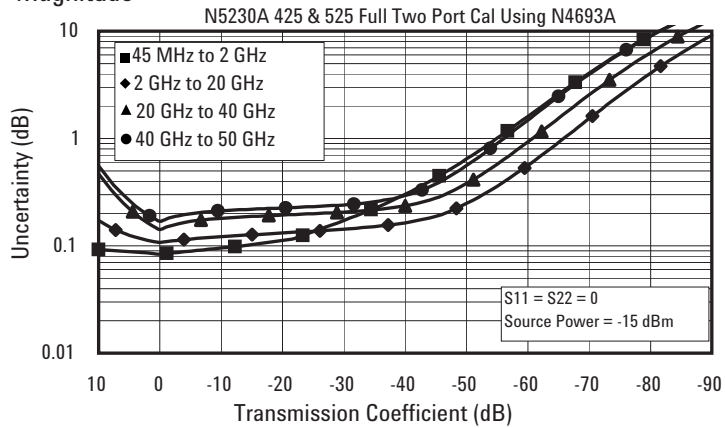

Phase

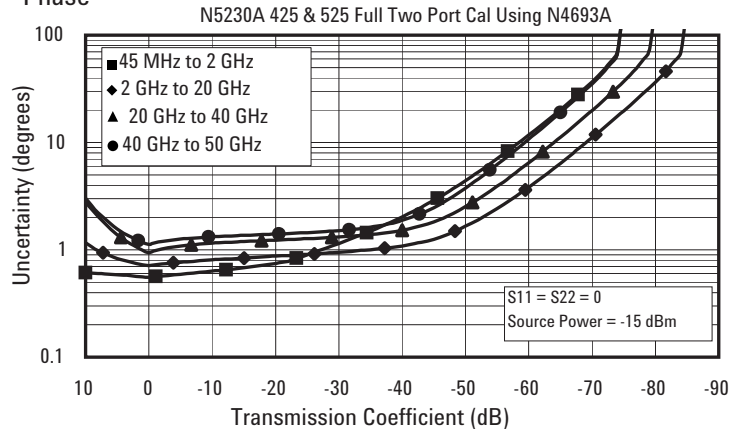

Reflection uncertainty (specifications)

Magnitude

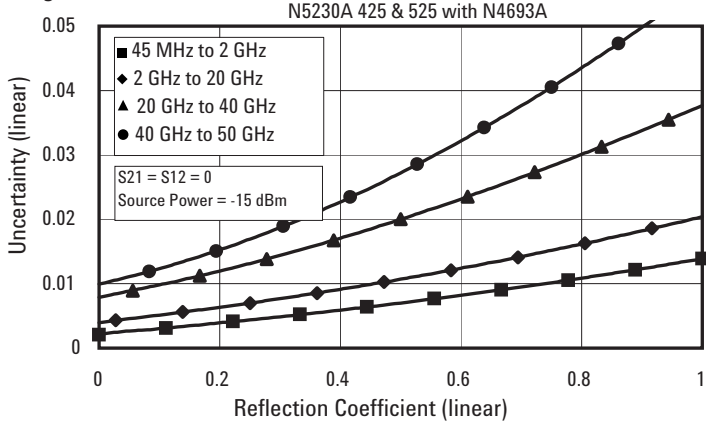

Phase

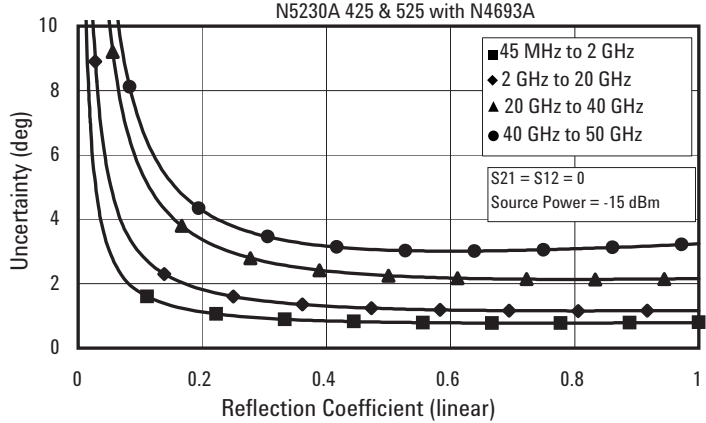

N5230A Corrected system performance with Type-N connectors

Table 8. 85032B Calibration kit

N5230A – configurable test set and extended power range (Option 025)

Configurable test set, extended power range

Applies to the N5230A Option 025 analyzers, 85032B (Type-N) calibration kit, 85132F flexible test port cable set with 85130C adapter set, and a full 2-port calibration. Also applies to the following condition: Environmental temperature $23^{\circ} \pm 3^{\circ} \text{C}$, with $< 1^{\circ} \text{C}$ deviation from calibration temperature.

Description	Specification (dB)			
	300 kHz to 1 MHz	1 MHz to 10 MHz	10 to 45 MHz	45 MHz to 6 GHz
Directivity	50	50	47	40
Source match	42	42	37	31
Load match	50	50	47	38
Reflection tracking	± 0.009 (+0.01/°C)	± 0.009 (+0.01/°C)	± 0.019 (+0.01/°C)	± 0.069 (+0.02/°C)
Transmission tracking	± 0.013 (+0.01/°C)	± 0.007 (+0.01/°C)	± 0.021 (+0.01/°C)	± 0.101 (+0.02/°C)

Transmission uncertainty (specifications)

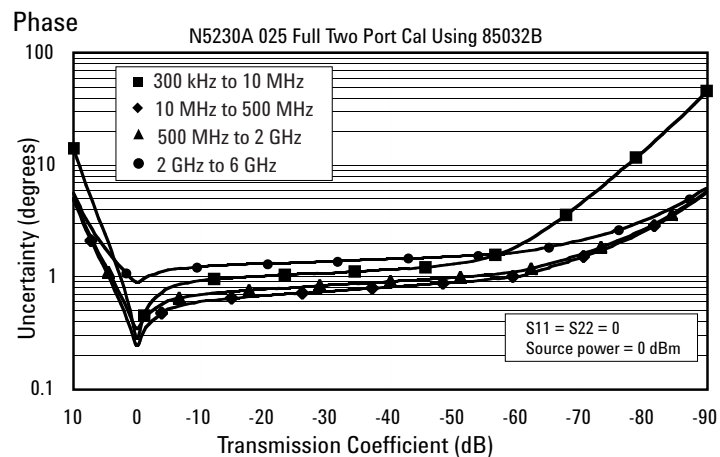
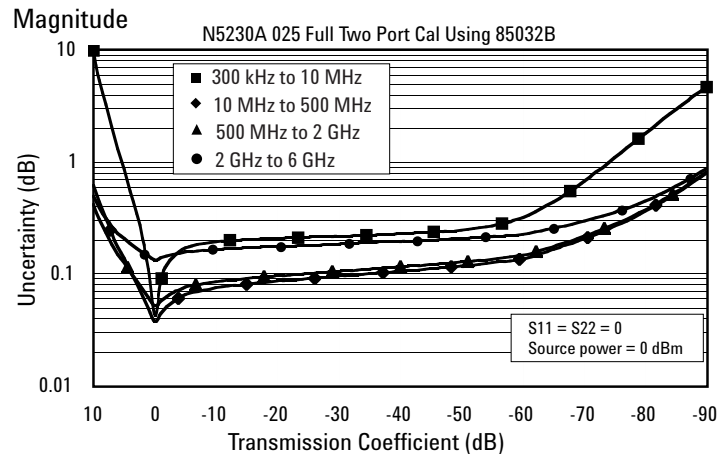

Transmission uncertainty (specifications)

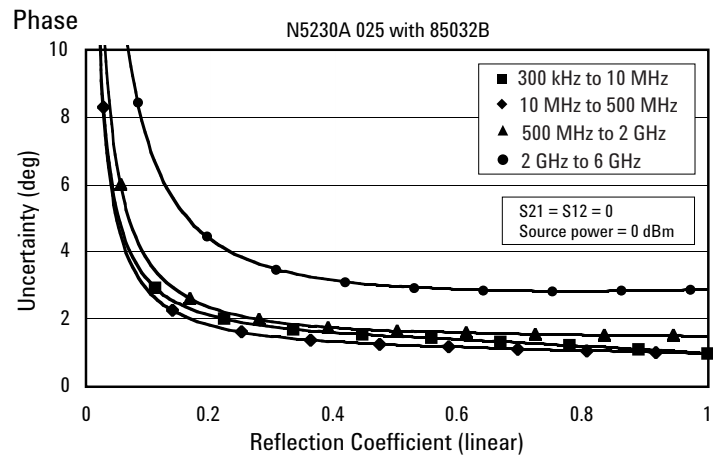
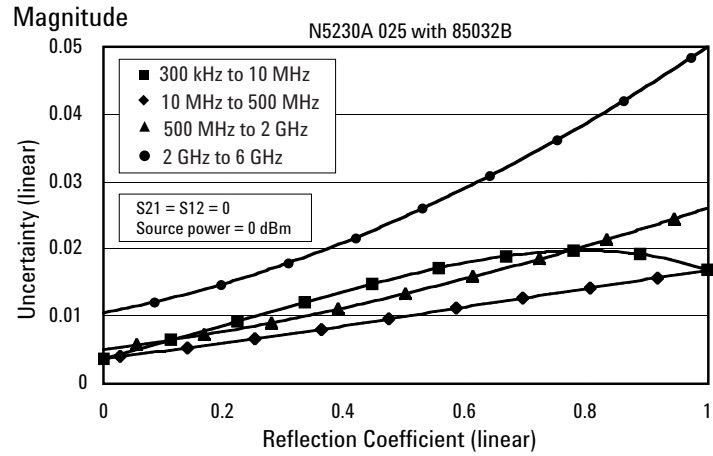

Table 9. Uncorrected system performance

Directivity	Specifications				Typicals			
	Option 020, 025, 120, 125	Option 220, 225	Option 420, 425	Option 520, 525	Option 020, 025, 120, 125	Option 220, 225	Option 420, 425	Option 520, 525
300 kHz to 10 MHz	16 dB				23 dB			
10 MHz to 45 MHz	28 dB						20 dB	20 dB
45 MHz to 500 MHz	28 dB	24 dB	23 dB	23 dB				
500 MHz to 1 GHz	28 dB	27 dB	23 dB	23 dB				
1 GHz to 2 GHz	25 dB	27 dB	23 dB	23 dB				
2 GHz to 3 GHz	25 dB	21 dB	21 dB	21 dB				
3 GHz to 5 GHz	20 dB	21 dB	21 dB	21 dB				
5 GHz to 8 GHz	17 dB	21 dB	21 dB	21 dB				
8 GHz to 11.5 GHz	17 dB	16 dB	16 dB	16 dB				
11.5 GHz to 13.5 GHz	15 dB	16 dB	16 dB	16 dB				
13.5 GHz to 20 GHz		16 dB	16 dB	16 dB				
20 GHz to 40 GHz			15 dB	15 dB				
40 GHz to 50 GHz				13 dB				
Source match	Option 020, 025, 120, 125	Option 220, 225	Option 420, 425	Option 520, 525	Option 020, 025, 120, 125	Option 220, 225	Option 420, 425	Option 520, 525
300 kHz to 10 MHz	18 dB							
10 MHz to 45 MHz	25 dB				12 dB		11 dB	11 dB
45 MHz to 500 MHz	25 dB	20 dB	17 dB	17 dB				
500 MHz to 2 GHz	21 dB	17 dB	17 dB	17 dB				
2 GHz to 3 GHz	19 dB	12 dB	12 dB	12 dB				
3 GHz to 8 GHz	12 dB	12 dB	12 dB	12 dB				
8 GHz to 9 GHz	12 dB	11 dB	11 dB	11 dB				
9 GHz to 12.5 GHz	10 dB	11 dB	11 dB	11 dB				
12.5 GHz to 13.5 GHz	8 dB	10 dB	11 dB	11 dB				
13.5 GHz to 20 GHz		10 dB	11 dB	11 dB				
20 GHz to 40 GHz			7 dB	7 dB				
40 GHz to 50 GHz				6 dB				
Load match	Option 020, 025, 120, 125	Option 220, 225	Option 420, 425	Option 520, 525	Option 020, 025, 120, 125	Option 220, 225	Option 420, 425	Option 520, 525
300 kHz to 10 MHz	17 dB							
10 MHz TO 45 MHz	22 dB				15 dB		13 dB	13 dB
45 MHz to 500 MHz	22 dB	22 dB	18 dB	18 dB				
500 MHz to 2 GHz	17 dB	20 dB	18 dB	18 dB				
2 GHz to 3 GHz	14 dB	12 dB	14 dB	14 dB				
3 GHz to 8 GHz	10 dB	12 dB	14 dB	14 dB				
8 GHz to 9 GHz	9 dB	10 dB	12 dB	12 dB				
9 GHz to 12.5 GHz	9 dB	10 dB	12 dB	12 dB				
12.5 GHz to 13.5 GHz	7 dB	9 dB	9 dB	9.5 dB				
13.5 GHz to 20 GHz		9 dB	9 dB	9.5 dB				
20 GHz to 40 GHz			8 dB	8.5 dB				
40 GHz to 50 GHz				5 dB				
Crosstalk¹	Option 020, 025, 120, 125	Option 220, 225	Option 420, 425	Option 520, 525	Option 020, 025, 120, 125	Option 220, 225	Option 420, 425	Option 520, 525
300 kHz to 10 MHz					80 dB			
10 MHz to 45 MHz					115 dB	88 dB	88 dB	88 dB
45 MHz to 500 MHz					122 dB	95 dB	94 dB	94 dB
500 MHz to 2 GHz					122 dB	96 dB	95 dB	95 dB
2 GHz to 8 GHz					122 dB	110 dB	108 dB	108 dB
8 GHz to 10.5 GHz					120 dB	116 dB	113 dB	113 dB
10.5 GHz to 12.5 GHz					115 dB	116 dB	113 dB	113 dB
12.5 GHz to 13.5 GHz					109 dB	115 dB	112 dB	112 dB
13.5 GHz to 20 GHz						115 dB	112 dB	112 dB
20 GHz to 40 GHz							97 dB	97 dB
40 GHz to 50 GHz								89 dB

1. Measurement conditions: normalized to a thru, measured with two shorts, 10 Hz IF bandwidth, averaging factor of 8, alternate mode, source power set to the the specified maximum power output or the minimum receiver input power specified by the 0.1 dB compression power.

Table 10. Test port output¹

Description	Specifications					Typicals			
	Option 020, 025	Option 120, 125	Option 220, 225	Option 420, 425	Option 520, 525	Option 020, 025, 120, 125	Option 220, 225	Option 420, 425	Option 520, 525
Frequency range									
N5230A	300 kHz to 6 GHz	300 kHz to 13.5 GHz	10 MHz to 20 GHz	10 MHz to 40 GHz	10 MHz to 50 GHz				
Nominal power									
Preset power; attenuator switch point 10 dB below nominal power	0 dBm	0 dBm	-5 dBm	-10 dBm	-15 dBm				
Frequency resolution	1 Hz								
CW accuracy	±1 ppm								
Frequency stability									±0.05 ppm, -10° to 70° C ±0.1 ppm/yr maximum

Description	Specifications					Typicals		
	Option 020, 025, 120, 125	Option 220, 225	Option 420, 425	Option 520	Option 525	Option 020, 025, 120, 125	Option 220, 225	Option 420, 425, 520, 525
Power level accuracy								
Variation from nominal power in range 0								
300 kHz to 10 MHz	±1.0 dB							
10 MHz to 45 MHz	±1.0 dB						±0.5 dB	±0.5 dB
45 MHz to 6 GHz	±1.0 dB	±1.0 dB	±1.0 dB	±1.0 dB	±1.0 dB			
6 GHz to 8 GHz	±1.5 dB	±1.0 dB	±1.0 dB	±1.0 dB	±1.0 dB			
8 GHz to 9 GHz	±1.5 dB	±1.0 dB	±1.5 dB	±1.5 dB	±1.5 dB			
9 GHz to 10.5 GHz	±1.5 dB	±1.0 dB	±1.5 dB	±1.5 dB	±1.5 dB			
10.5 GHz to 13.5 GHz	±2.0 dB	±1.0 dB	±1.5 dB	±1.5 dB	±1.5 dB			
13.5 GHz to 20 GHz		±1.0 dB	±1.5 dB	±1.5 dB	±1.5 dB			
20 GHz to 40 GHz			±2.5 dB	±2.5 dB	±2.5 dB			
40 GHz to 50 GHz				±3.5 dB	±3.5 dB			

Description	Specifications							Options as indicated
	Option 020, 120	Option 025, 125	Option 220, 225	Option 420	Option 425	Option 520	Option 525	
Max leveled power								
300 kHz to 10 MHz	10 dBm	9 dBm						
10 MHz to 45 MHz	10 dBm	9 dBm						
45 MHz to 6 GHz	10 dBm	9 dBm	5 dBm	0 dBm	0 dBm	0 dBm	0 dBm	
6 GHz to 9 GHz	8 dBm	8 dBm	5 dBm	0 dBm	0 dBm	0 dBm	0 dBm	
9 GHz to 12.5 GHz	4 dBm	4 dBm	5 dBm	0 dBm	0 dBm	0 dBm	0 dBm	
12.5 GHz to 13.5 GHz	2 dBm	1 dBm	3 dBm	0 dBm	0 dBm	0 dBm	0 dBm	
13.5 GHz to 20 GHz			3 dBm	0 dBm	0 dBm	0 dBm	0 dBm	
20 GHz to 40 GHz				-5 dBm	-8 dBm	-5 dBm	-8 dBm	
40 GHz to 50 GHz						-11 dBm	-15 dBm	
Power level linearity²								
Test reference is at the nominal power level								
300 kHz to 1 MHz	±4.5 dB	±4.5 dB						±2.0 dB (Opt 020, 025, 120, 125)
1 MHz to 10 MHz	±1.0 dB	±1.0 dB						
10 MHz to 45 MHz	±2.0 dB	±2.0 dB						±0.35 dB (Opt 220, 225) ±0.40 (Opt 420, 425, 520, 525)
45 MHz to 1 GHz	±2.0 dB	±2.0 dB	±1.0 dB	±1.0 dB	±1.0 dB	±1.0 dB	±1.0 dB	
1 GHz to 12.5 GHz	±1.5 dB	±1.5 dB	±1.0 dB	±1.0 dB	±1.0 dB	±1.0 dB	±1.0 dB	
12.5 GHz to 13.5 GHz	±1.5 dB	±1.5 dB	±1.0 dB	±1.0 dB	±1.0 dB	±1.0 dB	±1.0 dB	
13.5 GHz to 20 GHz			±1.0 dB	±1.0 dB	±1.0 dB	±1.0 dB	±1.0 dB	
20 GHz to 40 GHz				±1.0 dB	±1.0 dB	±1.0 dB	±1.0 dB	
40 GHz to 50 GHz						±1.0 dB	±1.0 dB	

1. Performance specified on Port 1 only. Port 2 performance is a characteristic.

2. Power level linearity specified on Port 1 only. Port 2 performance is typical.

Test reference is at the nominal power level.

Table 10. Test port output¹ (Continued)

Description	Specifications							Options as indicated
	Option 020, 120	Option 025, 125	Option 220, 225	Option 420	Option 425	Option 520	Option 525	
Power sweep range (ALC)²								
300 KHz to 10 MHz	37 dB	36 dB						
10 MHz to 45 MHz	37 dB	36 dB						
45 MHz to 6 GHz	37 dB	36 dB	25 dB	25 dB	25 dB	25 dB	25 dB	
6 GHz to 9 GHz	35 dB	35 dB	25 dB	25 dB	25 dB	25 dB	25 dB	
9 GHz to 12.5 GHz	31 dB	31 dB	25 dB	25 dB	25 dB	25 dB	25 dB	
12.5 GHz to 13.5 GHz	29 dB	28 dB	23 dB	25 dB	25 dB	25 dB	25 dB	
13.5 GHz to 20 GHz			23 dB	25 dB	25 dB	25 dB	25 dB	
20 GHz to 40 GHz				20 dB	17 dB	20 dB	17 dB	
40 GHz to 50 GHz						14 dB	10 dB	
Power resolution								
								0.01 dB

Description	Specification	Typicals					
		Option 020, 120	Option 025, 125	Option 220	Option 225	Option 420, 520	Option 425, 525
Power range							
300 kHz to 10 MHz		-30 to +10 dBm	-90 to +9 dBm				
10 MHz to 45 MHz		-30 to +10 dBm	-90 to +9 dBm	-27 to +14 dBm	-87 to +12 dBm	-27 to +9 dBm	-87 to +8 dBm
45 MHz to 6 GHz		-30 to +10 dBm	-90 to +9 dBm	-27 to +14 dBm	-87 to +12 dBm	-27 to +8 dBm	-87 to +8 dBm
6 GHz to 9 GHz		-30 to +8 dBm	-90 to +8 dBm	-27 to +14 dBm	-87 to +12 dBm	-27 to +8 dBm	-87 to +8 dBm
9 GHz to 12.5 GHz		-30 to +4 dBm	-90 to +4 dBm	-27 to +14 dBm	-87 to +12 dBm	-27 to +8 dBm	-87 to +8 dBm
12.5 GHz to 13.5 GHz		-30 to +2 dBm	-90 to +1 dBm	-27 to +10 dBm	-87 to +7 dBm	-27 to +5 dBm	-87 to +4 dBm
13.5 GHz to 20 GHz				-27 to +10 dBm	-87 to +7 dBm	-27 to +5 dBm	-87 to +4 dBm
20 GHz to 40 GHz						-27 to +1 dBm	-87 to -2 dBm
40 GHz to 50 GHz						-27 to -5 dBm	-87 to -9 dBm
Power settings							
Minimum power setting		-33 dBm	-93 dBm	-30 dBm	-90 dBm	-30 dBm	-90 dBm
Maximum power setting		+20 dBm	+20 dBm	+20 dBm	+20 dBm	+20 dBm	+20 dBm

Description	Specification	Typicals					
		Option 020, 025, 120, 125			Option 220, 225, 420, 425, 520, 525		
Phase noise (Nominal power at test port)							
		10 kHz Offset	100 kHz Offset	1 MHz Offset	10 kHz Offset	100 kHz Offset	1 MHz Offset
300 kHz to 10 MHz		-86 dBc/Hz	-86 dBc/Hz	-95 dBc/Hz	-77 dBc/Hz	-77 dBc/Hz	-40 dBc/Hz
10 MHz to 1.5 GHz		-86 dBc/Hz	-91 dBc/Hz	-95 dBc/Hz	-77 dBc/Hz	-77 dBc/Hz	-89 dBc/Hz
1.5 GHz to 3.125 GHz		-83 dBc/Hz	-91 dBc/Hz	-95 dBc/Hz	-83 dBc/Hz	-91 dBc/Hz	-95 dBc/Hz
3.125 GHz to 6.25 GHz		-77 dBc/Hz	-85 dBc/Hz	-89 dBc/Hz	-77 dBc/Hz	-85 dBc/Hz	-89 dBc/Hz
6.25 GHz to 12.5 GHz		-71 dBc/Hz	-79 dBc/Hz	-83 dBc/Hz	-71 dBc/Hz	-79 dBc/Hz	-83 dBc/Hz
12.5 GHz to 13.5 GHz		-65 dBc/Hz	-73 dBc/Hz	-77 dBc/Hz	-65 dBc/Hz	-73 dBc/Hz	-77 dBc/Hz
13.5 GHz to 20 GHz					-65 dBc/Hz	-73 dBc/Hz	-77 dBc/Hz
20 GHz to 40 GHz					-59 dBc/Hz	-67 dBc/Hz	-71 dBc/Hz
40 GHz to 50 GHz					-59 dBc/Hz	-67 dBc/Hz	-71 dBc/Hz
Non-harmonic spurious (at nominal output power)							
300 kHz to 10 MHz							
10 MHz to 13.5 GHz							-50 dBc for offset frequency > 1 kHz
13.5 GHz to 20 GHz							
20 GHz to 40 GHz							
40 GHz to 50 GHz							-30 dBc for offset frequency > 1 kHz

Description	Specification	Typicals			
		Option 020, 025, 120, 125	Option 220, 225	Option 420, 520	Option 425, 525
Harmonics (2nd or 3rd) at maximum output power					
300 kHz to 10 MHz		-17 dBc			
10 MHz to 500 MHz		-17 dBc	-22 dBc	-15 dBc	-15 dBc
500 MHz to 1 GHz		-17 dBc	-22 dBc	-15 dBc	-15 dBc
1 GHz to 13.5 GHz		-20 dBc	-22 dBc	-20 dBc	-20 dBc
13.5 GHz to 20 GHz			-22 dBc	-20 dBc	-20 dBc
20 GHz to 40 GHz				-22 dBc	-22 dBc
40 GHz to 50 GHz					-22 dBc

1. Performance specified on Port 1 only. Port 2 performance is a characteristic.

2. ALC range starts at maximum leveled power and decreases in power level indicated by the dB amount specified here.

Table 11: Test port input

Description	Specifications				Typicals			
	Option 020, 025, 120, 125	Option 220, 225	Option 420, 425	Option 520, 525	Option 020, 025, 120, 125	Option 220, 225	Option 420, 425	Option 520, 525
Test port noise floor¹ 10 Hz IF bandwidth								
300 kHz to 1 MHz	< -93 dBm				< -103 dBm			
1 MHz to 10 MHz	< -103 dBm				< -110 dBm			
10 MHz to 45 MHz	< -112 dBm				< -116 dBm	< -89 dBm	< -80 dBm	< -80 dBm
45 MHz to 70 MHz	< -112 dBm	< -96 dBm	< -90 dBm	< -90 dBm	< -116 dBm			
70 MHz to 500 MHz	< -112 dBm	< -100 dBm	< -90 dBm	< -90 dBm	< -116 dBm			
500 MHz to 2 GHz	< -112 dBm	< -105 dBm	< -110 dBm	< -110 dBm	< -120 dBm			
2 GHz to 4 GHz	< -112 dBm	< -105 dBm	< -110 dBm	< -110 dBm	< -120 dBm			
4 GHz to 8 GHz	< -112 dBm	< -105 dBm	< -110 dBm	< -110 dBm	< -119 dBm			
8 GHz to 10.5 GHz	< -112 dBm	< -105 dBm	< -100 dBm	< -100 dBm	< -119 dBm			
10.5 GHz to 13.5 GHz	< -107 dBm	< -105 dBm	< -100 dBm	< -100 dBm	< -114 dBm			
13.5 GHz to 20 GHz	< -105 dBm		< -100 dBm	< -100 dBm				
20 GHz to 31.5 GHz			< -100 dBm	< -100 dBm				
31.5 GHz to 40 GHz			< -95 dBm	< -95 dBm				
40 GHz to 50 GHz			< -90 dBm	< -90 dBm				
Test port noise floor¹ 1 KHz IF bandwidth								
300 kHz to 1 MHz	< -73 dBm				< -83 dBm			
1 MHz to 10 MHz	< -83 dBm				< -90 dBm			
10 MHz to 45 MHz	< -92 dBm				< -96 dBm	< -69 dBm	< -60 dBm	< -60 dBm
45 MHz to 70 MHz	< -92 dBm	< -76 dBm	< -70 dBm	< -70 dBm	< -96 dBm			
70 MHz to 500 MHz	< -92 dBm	< -80 dBm	< -70 dBm	< -70 dBm	< -96 dBm			
500 MHz to 2 GHz	< -92 dBm	< -85 dBm	< -90 dBm	< -90 dBm	< -100 dBm			
2 GHz to 4 GHz	< -92 dBm	< -85 dBm	< -90 dBm	< -90 dBm	< -100 dBm			
4 GHz to 8 GHz	< -92 dBm	< -85 dBm	< -90 dBm	< -90 dBm	< -99 dBm			
8 GHz to 10.5 GHz	< -92 dBm	< -85 dBm	< -80 dBm	< -80 dBm	< -99 dBm			
10.5 GHz to 13.5 GHz	< -87 dBm	< -85 dBm	< -80 dBm	< -80 dBm	< -94 dBm			
13.5 GHz to 20 GHz	< -85 dBm		< -80 dBm	< -80 dBm				
20 GHz to 31.25 GHz			< -80 dBm	< -80 dBm				
31.25 GHz to 40 GHz			< -75 dBm	< -75 dBm				
40 GHz to 50 GHz			< -70 dBm	< -70 dBm				

Description	Specifications				Typicals			
	Option 020, 125	Option 225	Option 425	Option 525	Option 020, 125	Option 225	Option 425	Option 525
Direct receiver access input noise floor¹ 10 Hz IF bandwidth								
300 kHz to 1 MHz	< -109 dBm							
1 MHz to 10 MHz	< -119 dBm							
10 MHz to 45 MHz	< -128 dBm				< -120 dBm < -126 dBm < -126 dBm			
45 MHz to 70 MHz	< -128 dBm	< -108 dBm	< -111 dBm	< -111 dBm				
70 MHz to 500 MHz	< -128 dBm	< -112 dBm	< -111 dBm	< -111 dBm				
500 MHz to 2 GHz	< -128 dBm	< -117 dBm	< -122 dBm	< -122 dBm				
2 GHz to 8 GHz	< -128 dBm	< -117 dBm	< -122 dBm	< -122 dBm				
8 GHz to 10.5 GHz	< -128 dBm	< -117 dBm	< -112 dBm	< -112 dBm				
10.5 GHz to 13.5 GHz	< -128 dBm	< -117 dBm	< -112 dBm	< -112 dBm				
13.5 GHz to 20 GHz	< -117 dBm		< -112 dBm	< -112 dBm				
20 GHz to 31.25 GHz			< -111 dBm	< -111 dBm				
31.25 GHz to 40 GHz			< -106 dBm	< -106 dBm				
40 GHz to 50 GHz			< -98 dBm	< -98 dBm				
Direct receiver access input noise floor¹ 1 KHz IF bandwidth								
300 kHz to 1 MHz	< -89 dBm							
1 MHz to 10 MHz	< -99 dBm							
10 MHz to 45 MHz	< -108 dBm				< -100 dBm < -106 dBm < -106 dBm			
45 MHz to 70 MHz	< -108 dBm	< -88 dBm	< -91 dBm	< -91 dBm				
70 MHz to 500 MHz	< -108 dBm	< -92 dBm	< -91 dBm	< -91 dBm				
500 MHz to 2 GHz	< -108 dBm	< -97 dBm	< -102 dBm	< -102 dBm				
2 GHz to 8 GHz	< -108 dBm	< -97 dBm	< -102 dBm	< -102 dBm				
8 GHz to 10.5 GHz	< -108 dBm	< -97 dBm	< -92 dBm	< -92 dBm				
10.5 GHz to 13.5 GHz	< -108 dBm	< -97 dBm	< -92 dBm	< -92 dBm				
13.5 GHz to 20 GHz	< -97 dBm		< -92 dBm	< -92 dBm				
20 GHz to 31.5 GHz			< -91 dBm	< -91 dBm				
31.5 GHz to 40 GHz			< -86 dBm	< -86 dBm				
40 GHz to 50 GHz			< -78 dBm	< -78 dBm				

1. Total average (rms) noise power calculated as the mean value of a linear magnitude trace expressed in dBm.

Table 11: Test port input (Continued)

Description	Specifications						Typicals
	Option 220, 225		Option 420, 520		Option 425, 525		
Compression level							
	Power	Compression	Power	Compression	Power	Compression	
10 MHz to 45 MHz ²							
45 MHz to 500 MHz	+5 dBm	0.10 dB	+5 dBm	0.40 dB	+5 dBm	0.40 dB	
500 MHz to 2 GHz	+5 dBm	0.15 dB	+5 dBm	0.77 dB	+5 dBm	0.67 dB	
2 GHz to 8 GHz	+5 dBm	0.21 dB	+5 dBm	0.75 dB	+5 dBm	0.55 dB	
8 GHz to 12.5 GHz	+5 dBm	0.21 dB	+5 dBm	0.56 dB	+5 dBm	0.51 dB	
12.5 GHz to 20 GHz	+3 dBm	0.20 dB	+5 dBm	0.79 dB	+5 dBm	0.69 dB	
20 GHz to 31.25 GHz			0 dBm	0.60 dB	0 dBm	0.50 dB	
31.25 GHz to 40 GHz			-3 dBm	0.55 dB	-3 dBm	0.60 dB	
40 GHz to 50 GHz			-3 dBm	0.66 dB	-3 dBm	0.71 dB	

Description	Specifications		Typicals
	Option 020, 120, 025, 125		
Compression level			
	Power	Compression	
300 kHz to 10 MHz	+8 dBm	1.0 dB	0.1 dB at +5 dBm
10 MHz to 50 MHz	+8 dBm	0.35 dB	
50 MHz to 1 GHz	+8 dBm	0.35 dB	
1 GHz to 6 GHz	+8 dBm	0.25 dB	
6 GHz to 8 GHz	+8 dBm	0.25 dB	
8 GHz to 12.5 GHz	+8 dBm	0.30 dB	
12.5 GHz to 13.5 GHz	+8 dBm	0.40 dB	

Description	Specifications		Typicals
	Option 020, 120, 025, 125		
Compression level – 0.1 dB			
	Power	Compression	
300 kHz to 10 MHz	+5 dBm	0.1 dB	
10 MHz to 1 GHz	+9 dBm	0.1 dB	
1 GHz to 12.5 GHz	+10 dBm	0.1 dB	
12.5 GHz to 13.5 GHz	+9 dBm	0.1 dB	

Description	Specifications			Typicals		
	Option 220, 225	Option 420, 425	Option 520, 525	Option 220, 225	Option 420, 425	Option 520, 525
Test port compression - 0.1 dB						
300 kHz to 10 MHz						
10 MHz to 45 MHz ²				negligible	negligible	negligible
45 MHz to 500 MHz				+10 dBm	0.0 dBm	+1.0 dBm
500 MHz to 2 GHz				+9 dBm	0.0 dBm	+1.0 dBm
2 GHz to 12.5 GHz				+6 dBm	0.0 dBm	+1.5 dBm
12.5 GHz to 13.5 GHz				+6 dBm	-1.0 dBm	0.0 dBm
13.5 GHz to 20 GHz				+6 dBm	-1.0 dBm	0.0 dBm
20 GHz to 31.25 GHz					-5.5 dBm	-3.0 dBm
31.25 GHz to 40 GHz					-8.5 dBm	-7.5 dBm
40 GHz to 50 GHz						-10.0 dBm
Trace noise magnitude³						
1 kHz IF bandwidth , ratioed measurement, nominal power at test port.						
300 kHz to 10 MHz						
10 MHz to 45 MHz				0.004 dB rms	0.015 dB rms	0.015 dB rms
45 MHz to 500 MHz	0.004 dB rms	0.010 dB rms	0.010 dB rms			
500 MHz to 2 GHz	0.004 dB rms	0.006 dB rms	0.006 dB rms			
2 GHz to 10.5 GHz	0.004 dB rms	0.006 dB rms	0.006 dB rms			
10.5 GHz to 13.5 GHz	0.006 dB rms	0.010 dB rms	0.010 dB rms			
13.5 GHz to 20 GHz	0.006 dB rms	0.010 dB rms	0.010 dB rms			
20 GHz to 31.25 GHz		0.010 dB rms	0.010 dB rms			
31.25 GHz to 40 GHz		0.020 dB rms	0.020 dB rms			
40 GHz to 50 GHz			0.020 dB rms			

1. Total average (rms) noise power calculated as the mean value of a linear magnitude trace expressed in dBm.
2. Coupler roll-off will reduce compression to a negligible level below 45 MHz.
3. 1 kHz IF BW, ratioed measurement, nominal power at the test port.
4. Stability is defined as a ratio measurement made at the test port.

Table 11: Test port input (Continued)

Description	Specifications		Typicals	
	Option 020, 120, 025, 125		Option 020, 120, 025, 125	
Trace noise magnitude³ (continued)				
100 kHz IF bandwidth , ratioed measurement, nominal power at test port.				
300 kHz to 10 MHz	12 mdB			
10 MHz to 6 GHz	4 mdB			
6 GHz to 10.5 GHz	4 mdB			
10.5 GHz to 13.5 GHz	8 mdB			
600 kHz IF bandwidth , ratioed measurement, nominal power at test port.				
300 kHz to 10 MHz			20 mdB	
10 MHz to 6 GHz			8 mdB	
6 GHz to 10.5 GHz			8 mdB	
10.5 GHz to 13.5 GHz			10 mdB	

Description	Specifications			Typicals		
	Option 220, 225	Option 420, 425	Option 520, 525	Option 220, 225	Option 420, 425	Option 520, 525
Trace noise phase³						
1 kHz IF bandwidth , ratioed measurement, nominal power at test port.						
300 kHz to 10 MHz						
10 MHz to 45 MHz				0.025° rms	0.100° rms	0.100° rms
45 MHz to 500 MHz	0.060° rms	0.100° rms	0.100° rms			
500 MHz to 2 GHz	0.060° rms	0.060° rms	0.060° rms			
2 GHz to 10.5 GHz	0.060° rms	0.060° rms	0.060° rms			
10.5 GHz to 13.5 GHz	0.060° rms	0.100° rms	0.100° rms			
13.5 GHz to 20 GHz	0.060° rms	0.100° rms	0.100° rms			
20 GHz to 31.5 GHz			0.100° rms			
31.5 GHz to 40 GHz			0.200° rms			
40 GHz to 50 GHz			0.200° rms			

Description	Specifications			Typicals		
	Option 020, 120, 025, 125			Option 020, 120, 025, 125		
Trace noise phase³						
100 kHz IF bandwidth , ratioed measurement, nominal power at test port.						
300 kHz to 10 MHz	80 mdeg					
10 MHz to 6 GHz	30 mdeg					
6 GHz to 10.5 GHz	30 mdeg					
10.5 GHz to 13.5 GHz	60 mdeg					
600 kHz IF bandwidth , ratioed measurement, nominal power at test port.						
300 kHz to 10 MHz				100 mdeg		
10 MHz to 6 GHz				60 mdeg		
6 GHz to 10.5 GHz				60 mdeg		
10.5 GHz to 13.5 GHz				80 mdeg		

Description	Specifications			Typicals		
	Option 020, 025, 120, 125, 220, 225, 420, 425, 520, 525			Option 020, 025, 120, 125, 220, 225, 420, 425, 520, 525		
Reference level magnitude						
Range	±200 dB					
Resolution	0.001 dB					
Reference level phase						
Range	±500°					
Resolution	0.01°					

1. Total average (rms) noise power calculated as the mean value of a linear magnitude trace expressed in dBm.
2. Coupler roll-off will reduce compression to a negligible level below 45 MHz.
3. 1 kHz IF BW, ratioed measurement, nominal power at the test port.
4. Stability is defined as a ratio measurement made at the test port.

Table 11: Test port input (Continued)

Description	Specifications			Typicals		
	Option 020, 025, 120, 125	Option 220, 225	Option 420, 425, 520, 525	Option 020, 025, 120, 125	Option 220, 225	Option 420, 425, 520, 525
Stability magnitude⁴						
300 kHz to 10 MHz				±0.015 dB/°C		
10 MHz to 45 MHz				±0.010 dB/°C	±0.015 dB/°C	±0.015 dB/°C
45 MHz to 500 MHz				±0.010 dB/°C	±0.010 dB/°C	±0.010 dB/°C
500 MHz to 2 GHz				±0.010 dB/°C	±0.010 dB/°C	±0.010 dB/°C
2 GHz to 4 GHz				±0.015 dB/°C	±0.020 dB/°C	±0.010 dB/°C
4 GHz to 8 GHz				±0.020 dB/°C	±0.020 dB/°C	±0.010 dB/°C
8 GHz to 13.5 GHz				±0.020 dB/°C	±0.030 dB/°C	±0.015 dB/°C
13.5 GHz to 20 GHz					±0.030 dB/°C	±0.015 dB/°C
20 GHz to 40 GHz						±0.040 dB/°C
40 GHz to 50 GHz						±0.060 dB/°C
Stability phase⁴						
300 kHz to 10 MHz				±0.30°/°C		
10 MHz to 45 MHz				±0.025°/°C	±0.25°/°C	±0.25°/°C
45 MHz to 500 MHz				±0.035°/°C	±0.20°/°C	±0.22°/°C
500 MHz to 2 GHz				±0.050°/°C	±0.15°/°C	±0.22°/°C
2 GHz to 4 GHz				±0.10°/°C	±0.15°/°C	±0.10°/°C
4 GHz to 8 GHz				±0.15°/°C	±0.15°/°C	±0.10°/°C
8 GHz to 13.5 GHz				±0.30°/°C	±0.45°/°C	±0.15°/°C
13.5 GHz to 20 GHz					±0.45°/°C	±0.15°/°C
20 GHz to 40 GHz						±0.40°/°C
40 GHz to 50 GHz						±0.40°/°C

Directivity	Specifications		Typicals	
	Option 020, 120	Option 220, 420, 520	Option 025, 125	Option 225, 425, 525
Damage input level				
Test port 1 and 2	+27 dBm or ±16 VDC	+30 dBm or ±40 VDC	+27 dBm or ±16 VDC	+27 dBm or ±16 VDC
R1, R2 in			+15 dBm or ±16 VDC	+15 dBm or ±7 VDC
A, B in			+15 dBm or ±16 VDC	+15 dBm or ±7 VDC
Coupler thru			+27 dBm or ±16 VDC	+30 dBm or ±40 VDC
Coupler arm			+15 dBm or ±0 VDC	+30 dBm or ±7 VDC
Source out (reference)			+20 dBm or ±16 VDC	+20 dBm or ±7 VDC
Source out (test ports)			+27 dBm or ±16 VDC	+30 dBm or ±7 VDC

1. Total average (rms) noise power calculated as the mean value of a linear magnitude trace expressed in dBm.
2. Coupler roll-off will reduce compression to a negligible level below 45 MHz.
3. 1 kHz IF BW, ratioed measurement, nominal power at the test port.
4. Stability is defined as a ratio measurement made at the test port.

Dynamic Accuracy

Note: More dynamic accuracy uncertainty curves are available within the PNA-L network analyzer's internal Help system. Please download our free uncertainty calculator from www.agilent.com/find/na_calculator to generate the curves for your calibration kit and PNA setup.

Dynamic accuracy, 300 kHz to 8 GHz, Option 020, 025, 120, or 125

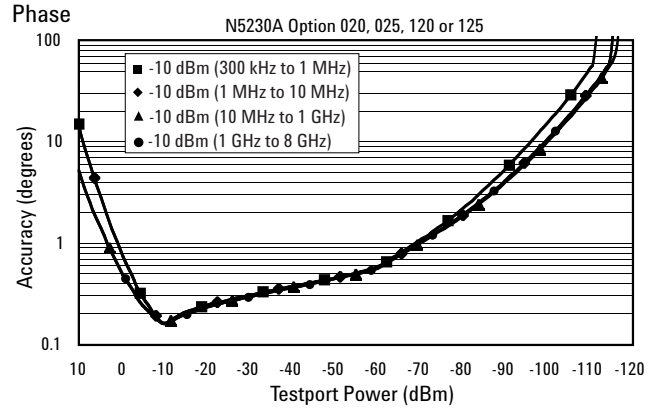
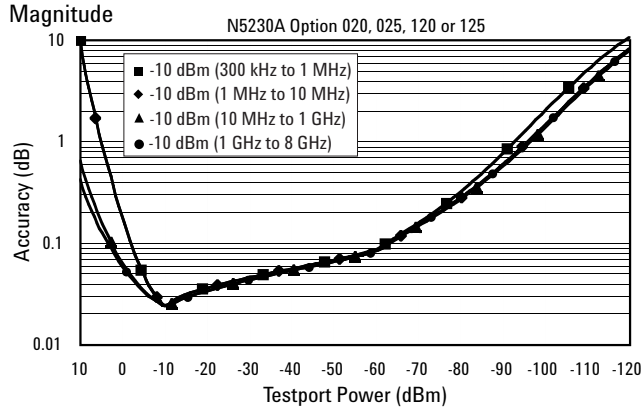

Dynamic accuracy, 8 to 13.5 GHz, Option 120, or 125

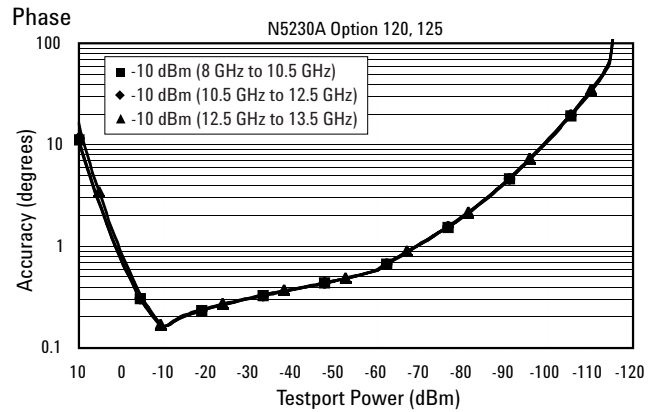
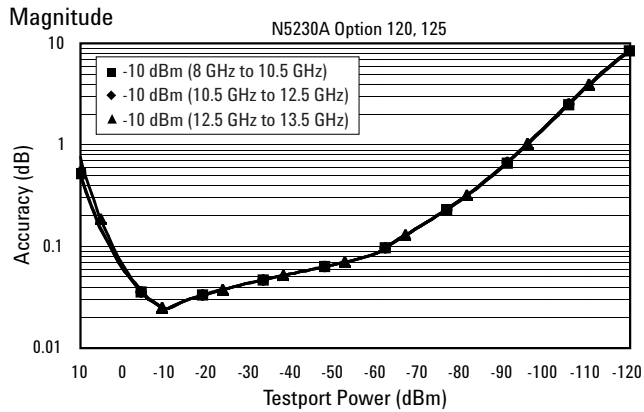

Dynamic accuracy, 12.5 to 20 GHz, Option 220, or 225

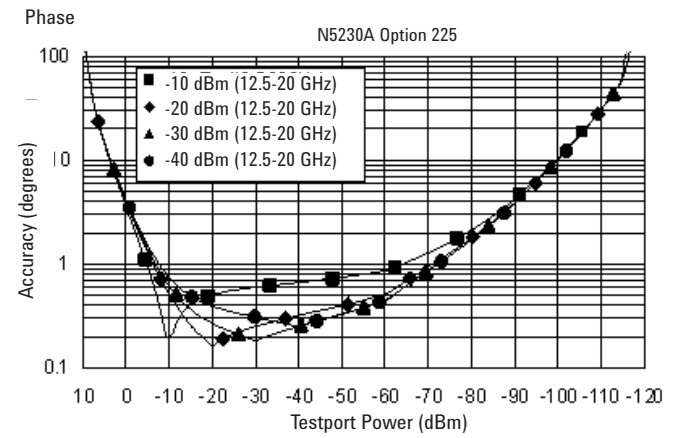
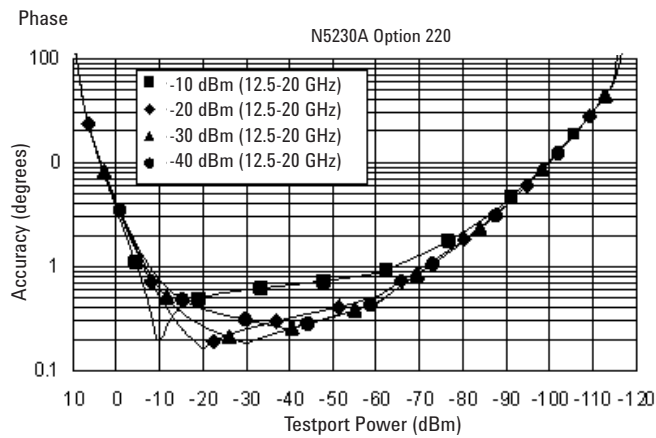
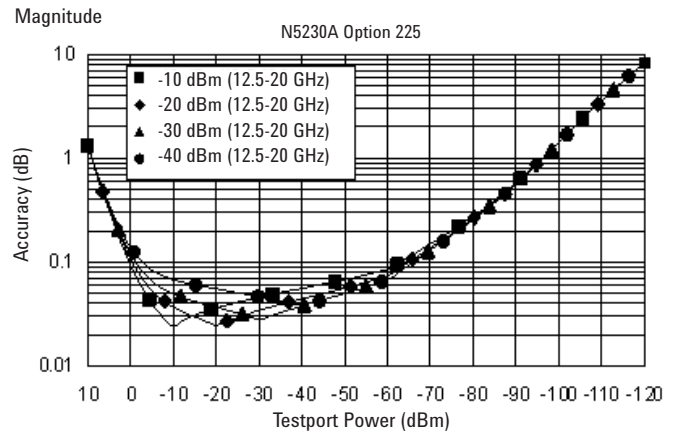
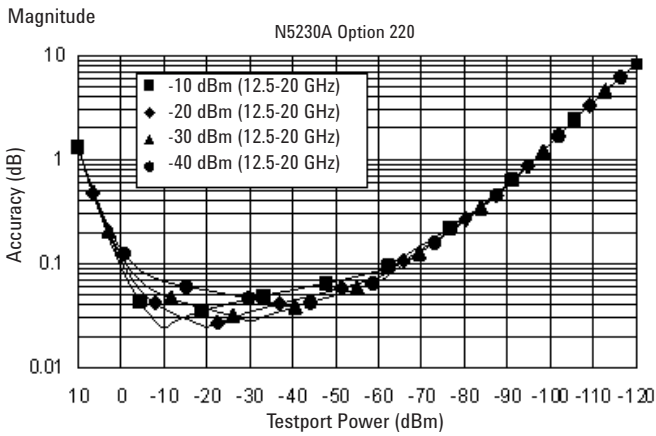

Dynamic accuracy, 12.5 to 20 GHz, Option 420, 425, 520, or 525

Magnitude

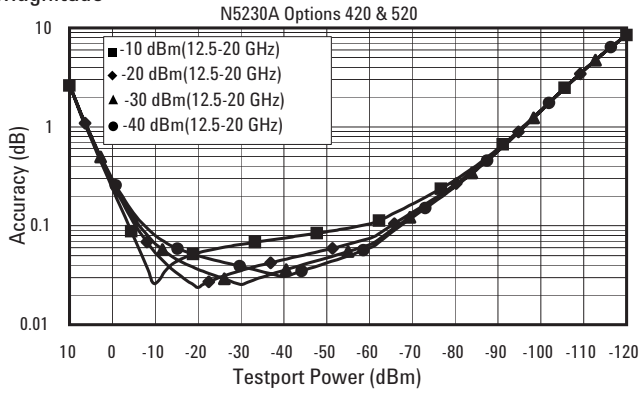

Magnitude

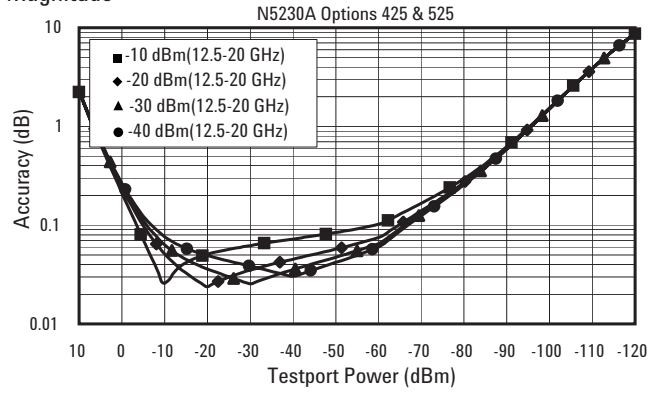

Phase

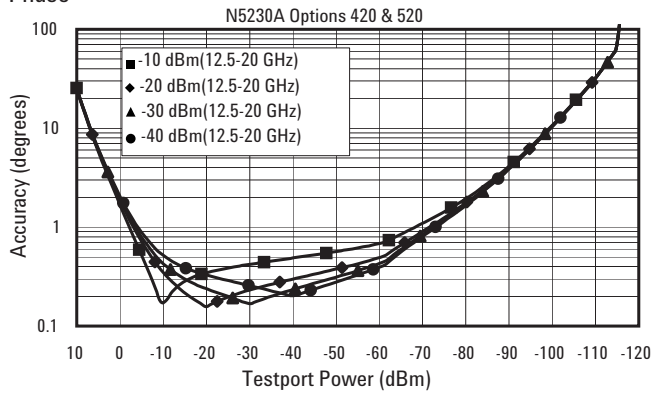

Phase

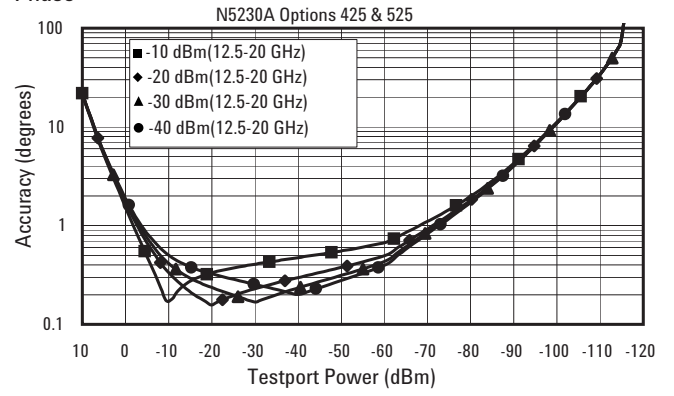

Dynamic accuracy, 20 to 31.25 GHz, Option 420, 425, 520, or 525

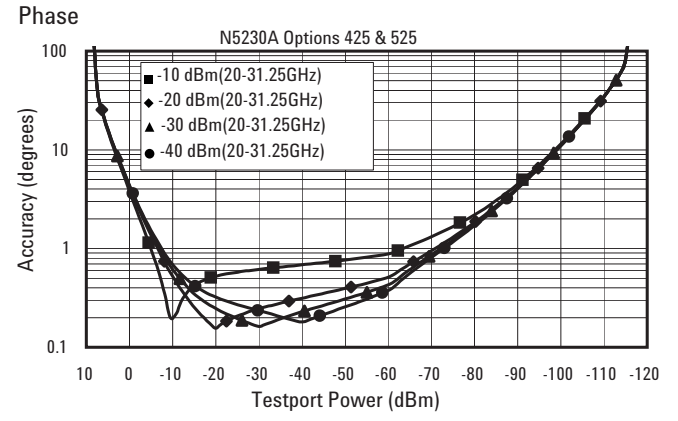
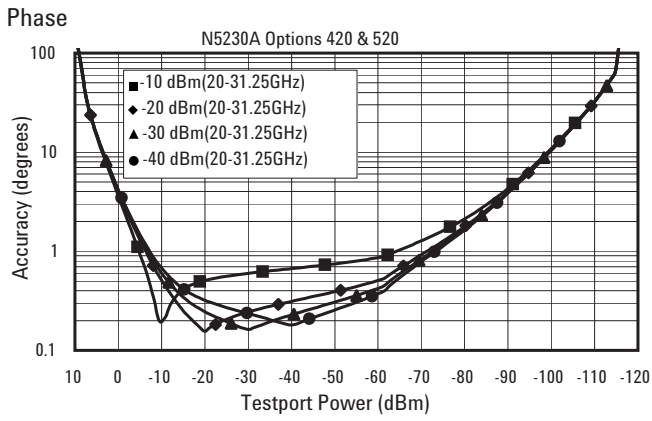
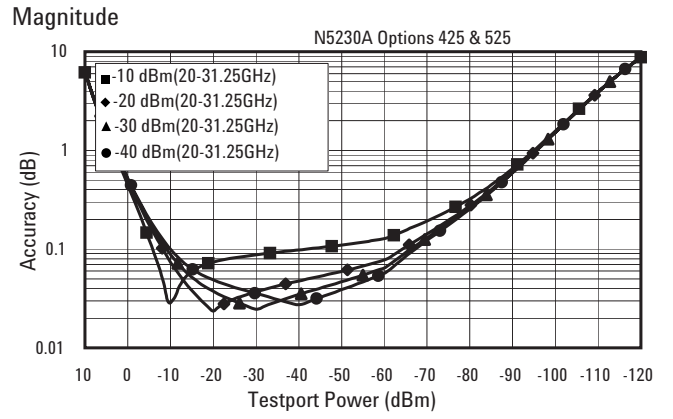
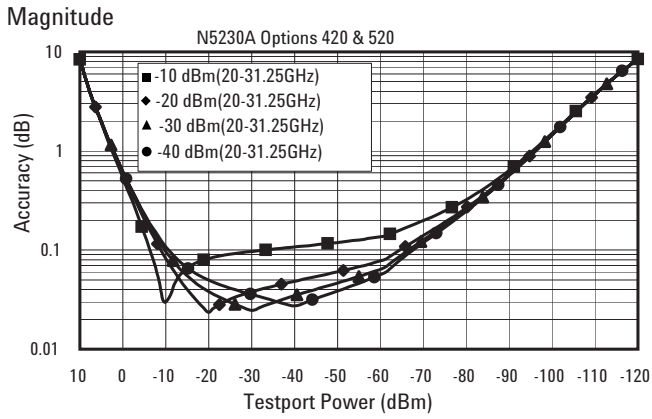

Dynamic accuracy, 31.25 to 40 GHz, Option 420, 425, 520, or 525

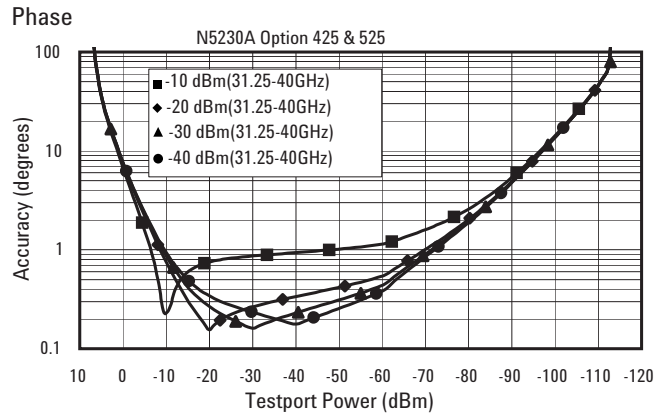
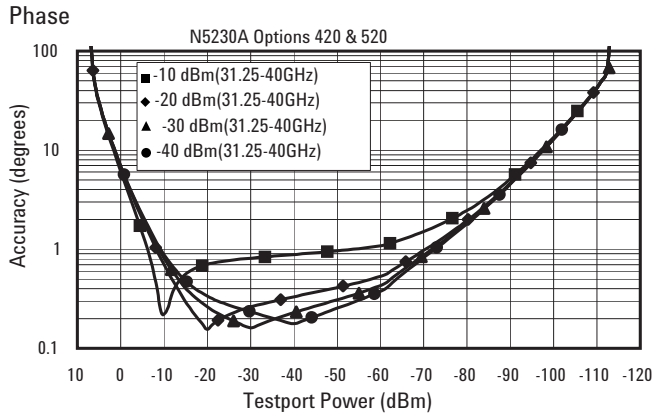
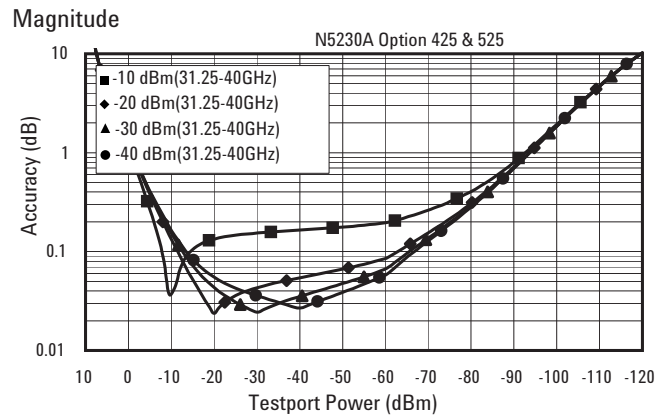
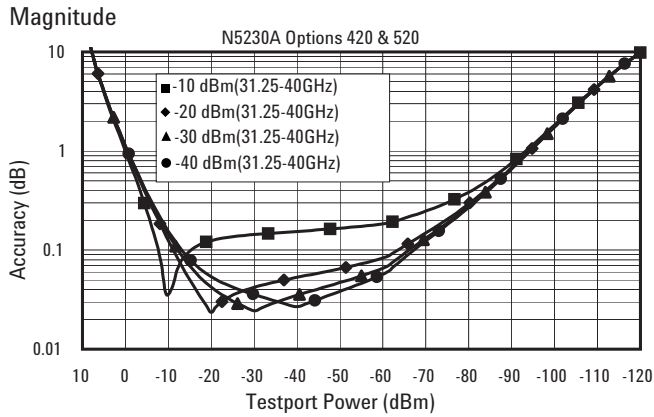

Dynamic accuracy, 40 to 50 GHz, , Option 520, or 525

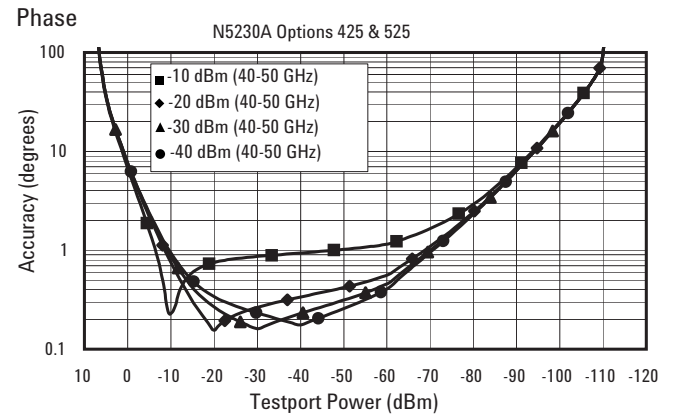
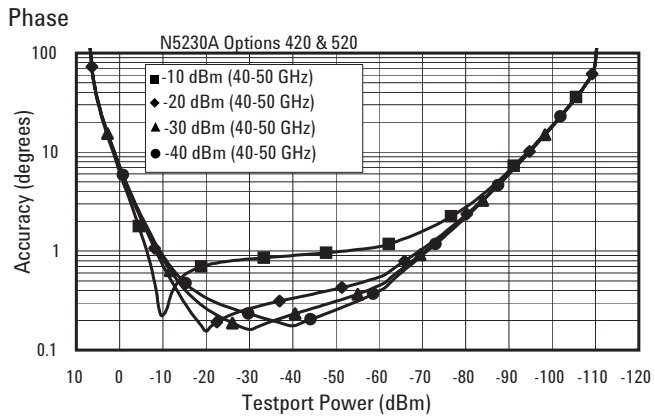
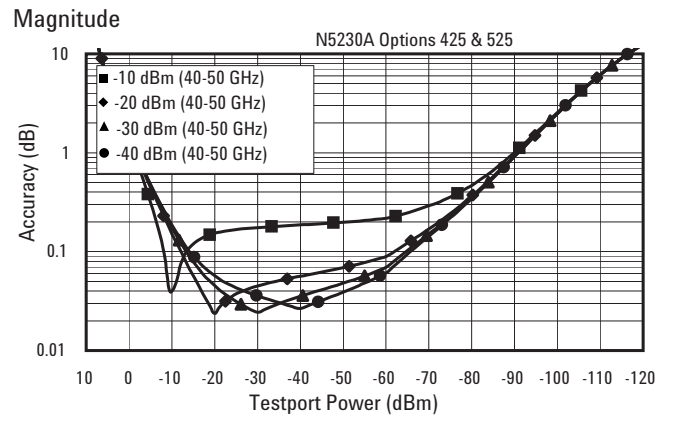
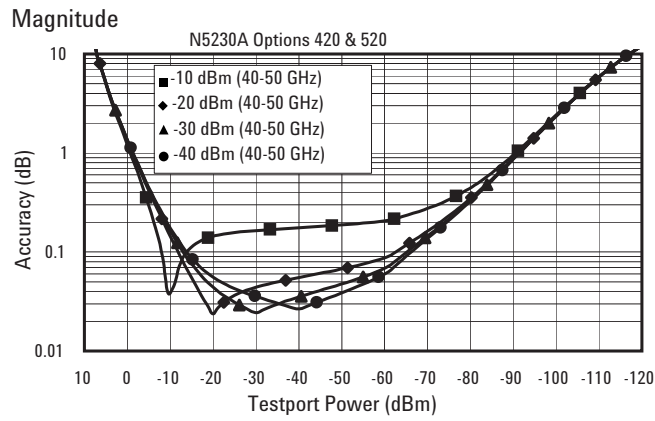
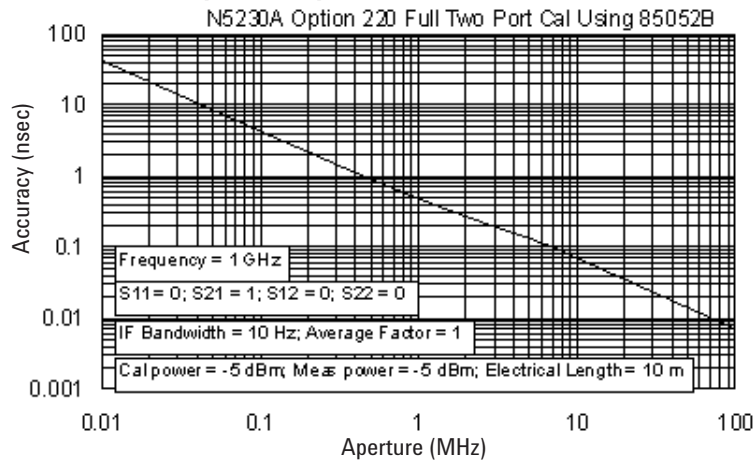

Table 12. Test port input (group delay)¹

Description	Specification	Supplemental information (typ.)
Aperture (selectable)		(frequency span)/(number of points -1)
Maximum aperture		20% of frequency span
Range		0.5 x (1/minimum aperture)
Maximum delay		Limited to measuring no more than 180° of phase change within the minimum aperture
Accuracy		See graph below. Char.

The following graph shows characteristic group delay accuracy with full 2-port calibration and a 10 Hz IF bandwidth. Insertion loss is assumed to be < 2 dB and electrical length to be ten meters.

Group delay (typical)



In general, the following formula can be used to determine the accuracy, in seconds, of specific group delay measurement:

$$\pm \text{Phase Accuracy (deg)} / [360^\circ \text{ Aperture (Hz)}]$$

Depending on the aperture and device length, the phase accuracy used is either incremental phase accuracy or worst case phase accuracy.

1. Group delay is computed by measuring the phase change within a specified frequency step (determined by the frequency span and the number of points per sweep).

General Information

Table 13. Miscellaneous information

Description	Supplemental information
System IF bandwidth range	Option 020, 025, 120, 125
	Option 220, 225, 420, 425, 520, 525
CPU	Intel® 500 MHz Pentium® III

Table 14. Front panel information

Description	Supplemental information
RF connectors	
N5230A	
Type	Option 020, 025, 120, 125, 220 or 225: 3.5 mm (male), 50 ohm, (nominal) Option 420, 425, 520, or 525: 2.4 mm (male), 50 ohm, (nominal)
Center pin recession	0.002 in. (characteristic)
Display	
Size	21.3 cm (8.4 in) diagonal color active matrix LCD; 640 (horizontal) X 480 (vertical) resolution
Refresh rate	Vertical 59.83 Hz; Horizontal 31.41 kHz
Pixels	When running the analyzer's built-in "Display Test ¹ ", one or more of the following symptoms indicate a faulty display assembly: <ul style="list-style-type: none"> • A complete row or column of "stuck" or "dark" pixels • More than six "stuck on" pixels (but not more than three green) • More than twelve "dark" pixels (but no more than seven of the same color) "Stuck on" or "dark" pixels less than 6.5 mm apart (excluding consecutive pixels)
Display range	
Magnitude	±500 dB (at 20 dB/div), max
Phase	±500°, max
Polar	10 pUnits, min 1000 Units, max
Display resolution	
Magnitude	0.001 dB/div, min
Phase	0.01°/div, min
Marker resolution	
Magnitude	0.001 dB, min
Phase	0.01°, min
Polar	0.01 mUnit, min; 0.01°, min

1. Any PNA Service Guide contains instructions for running the analyzer's built-in Display Test¹. You can view a PDF file of a Service Guide on the Web at www.agilent.com/find/pna. After opening the PDF file, look in the left-side column and then click on the "Index" bookmark. From the index, click on "Display Test".

Table 15. Rear panel information

Description	Supplemental information
10 MHz Reference in	
Connector	BNC, female
Input frequency	10 MHz \pm 10 ppm, typical
Input level	-15 dBm to +20 dBm, typical
Input impedance	200 W, nom.
10 MHz Reference out	
Connector	BNC, female
Output frequency	10 MHz \pm 1 ppm, typical
Signal type	Sine Wave, typical
Output level	+10 dBm \pm 4 dB into 50 W, typical
Output impedance	50 W, nominal
Harmonics	< -40 dBc, typical
VGA Video output	
Connector	15-pin mini D-Sub; Drives VGA compatible monitors
Devices supported:	
	Resolutions:
Flat panel (TFT)	1024 X 768, 800 X 600, 640 X 480
Flat panel (DSTN)	800 X 600, 640 X 480
CRT monitor	1280 X 1024, 1024 X 768, 800 X 600, 640 X 480
	Simultaneous operation of the internal and external displays is allowed, but with 640 X 480 resolution only. If you change resolution, you can only view the external display (internal display will "white out").
Test set IO	
	25-pin D-Sub connector, available for external test set control
Aux IO	
	25-pin D-Sub connector, male, analog and digital IO
Handler IO	
	36-pin parallel I/O port; all input/output signals are default set to negative logic; can be reset to positive logic via GPIB command
GPIB	
	24-pin D-sub (Type D-24), female; compatible with IEEE-488.
Parallel port (LPT1)	
	25-pin D-Sub miniature connector, female; provides connection to printers or any other parallel port peripherals
Serial Port (COM 1)	
	9-pin D-Sub, male; compatible with RS-232
USB Port	
	One port on front panel and five ports on rear panel. Universal Serial Bus jack, Type A configuration (4 contacts inline, contact 1 on left); female
Contact 1	Vcc: 4.75 to 5.25 VDC, 500 mA, maximum
Contact 2	-Data
Contact 3	+Data
Contact 4	Ground
LAN	
	10/100BaseT Ethernet, 8-pin configuration; auto selects between the two data rates

Table 15. Rear panel information (continued)

Description	Supplemental information
Line power¹ (single phase)	
Frequency	50/60 Hz/400 Hz
Voltage	120 to 240 VAC (power supply is auto switching)
Maximum	500 Watts

1. A third-wire ground is required.

Note: Option H08 and Option H11 specifications are not provided in this N5230A specifications document.

Table 16. Analyzer environment and dimensions

Description	Supplemental information
General environmental	
EMC	Complies with European EMC directive 89/336/EEC, amended by 93/68/EEC <ul style="list-style-type: none"> • IEC/EN 61326 • CISPR Pub 11 Group 1, class A • AS/NZS 2064 • ICES/NMB-001
Safety	Complies with European Low Voltage Directive 73/23/EEC, amended by 93/68/EEC <ul style="list-style-type: none"> • IEC/EN 61010 • Canada: CSA C22.2 No. 61010 • USA: UL 61010B
ESD	Minimize using static-safe work procedures and an antistatic bench mat
Dust	Minimize for optimum reliability
Operating environment	
Temperature	0 °C to +40 °C Instrument powers up and displays no error messages within this temperature range (except for "source unlevelled" error message that may occur at temperatures outside the specified performance temperature range of 25 ± 5 °C).
Error-corrected temperature range	23 °C ± 3 °C with less than 1 °C deviation from calibration temp.
Altitude	0 to 4500 m (14,760 ft.)
Non-operating storage environment	
Temperature	-40 °C to +70 °C
Cabinet dimensions	
	Height Width Depth
Excluding front and rear panel hardware and feet	267 mm 426 mm 427 mm 10.5 in 16.75 16.8 in
As shipped - includes front panel connectors, rear panel bumpers, and feet.	280 mm 435 mm 470 mm 11 in 17.10 in 18.5 in
As shipped plus handles	280 mm 458 mm 501 mm 11 in 18 in 19.7 in
As shipped plus rack-mount flanges	280 mm 483 mm 470 mm 11 in 19 in 18.5 in
As shipped plus handles and rack-mount flanges	280 mm 483 mm 501 mm 11 in 19 in 19.7 in
Weight	
Net	
N5230A	24.9 kg (55 lb), nominal
Shipping	
N5230A	36.3 kg (80 lb), nominal

N5230A

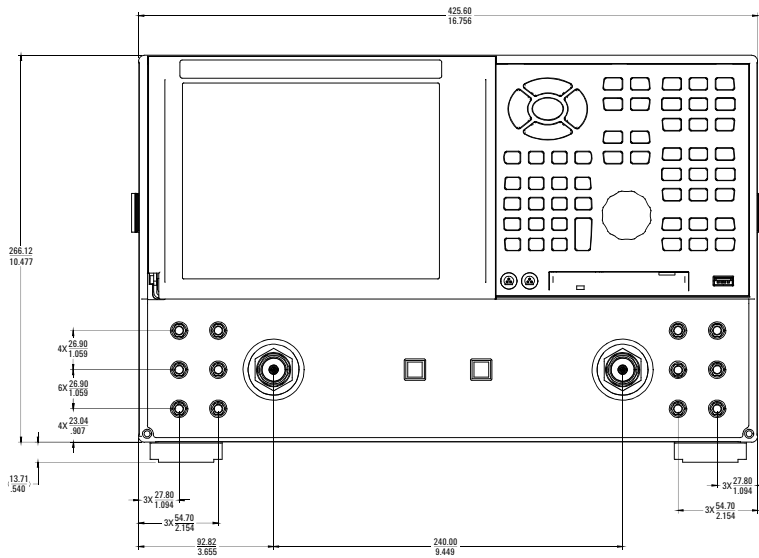

Measurement Throughput Summary

Table 17. Typical cycle time^{1,2} (ms) for measurement completion

	Number of Points				
	201	401	801	1601	16,001
Start 8 GHz, stop 18 GHz, 30 kHz IF bandwidth					
Uncorrected	97.5	102.7	103.8	108.2	683.9
2-Port cal	203.7	213.5	218.5	234.6	1504.3
Start 10 MHz, stop 10 GHz, 30 kHz IF bandwidth					
Uncorrected	112.6	120.6	124.8	138.2	738.4
2-Port cal	232.8	251.8	265.2	304.3	1623.4
Start 10 MHz, stop 20 GHz, 30 kHz IF bandwidth					
Uncorrected	146	199.3	210.9	217.2	753.9
2-Port cal	302.3	410.5	438.7	462.5	1660.5
Start 8 GHz, stop 18 GHz, 50 kHz IF bandwidth					
Uncorrected	79.1	81	81.7	86.6	482
2-Port cal	164.5	170.3	175.3	193.5	1104.7
Start 10 MHz, stop 10 GHz, 50 kHz IF bandwidth					
Uncorrected	96.8	101.7	108.8	122.2	524.6
2-Port cal	202.1	215.6	236.7	276.7	1198.8
Start 10 MHz, stop 20 GHz, 50 kHz IF bandwidth					
Uncorrected	141.6	163.9	170.7	179.7	546.5
2-Port cal	293.6	341	360	389.5	1248.8

1. Typical performance.
2. Includes sweep time, retrace time and band-crossing time. Analyzer display turned off with DISPLAY:ENABLE OFF. Add 21 ms for display on. Data for one trace (S11) measurement.

Table 18. Cycle Time vs IF bandwidth¹ (Options 020, 025, 120, 125 only)

Applies to the preset condition (201 points, correction off) except for the following changes:

- CF = 10 GHz
- Span = 100 MHz
- Display off (add 21 ms for display on)

Description		Typical performance
IF Bandwidth (Hz)	Cycle time (ms)²	Trace noise (dB rms)
600,000	7	0.0035
360,000	7	0.0026
280,000	7	0.0022
200,000	7	0.0021
150,000	7	0.0016
100,000	7	0.0012
70,000	7	0.0011
50,000	9	0.0009
30,000	11	0.0008
20,000	14	0.0006
15,000	17	0.0005
10,000	28	0.0004
7,000	37	0.0004
5,000	48	0.0003
3,000	72	0.0003
2,000	102	0.0002
1,500	130	0.0001
1,000	218	0.0001
700	294	0.0001
500	399	0.0001
300	636	0.0001
200	932	negligible
100	1,826	negligible
30	6,004	negligible
10	17,903	negligible
1	178,398	negligible

1. Typical performance.
2. Cycle time includes sweep and retrace time.

Table 19. Cycle Time vs IF bandwidth¹ (Options 220, 225, 420, 425, 520, 525 only)

Applies to the preset condition (201 points, correction off) except for the following changes:

- CF = 10 GHz
- Span = 100 MHz
- Display off (add 21 ms for display on)

Description		Typical performance
IF Bandwidth (Hz)	Cycle time (ms)²	Cycle time (ms) Option 080 enabled
250,000	8	37
200,000	9	39
150,000	9	40
100,000	10	41
70,000	11	43
50,000	12	45
30,000	15	50
20,000	18	53
15,000	21	57
10,000	27	65
7,000	34	75
5,000	48	93
3,000	72	124
2,000	108	169
1,500	126	187
1,000	272	
700	357	
500	460	
300	697	
200	1003	
150	1307	
100	1917	
30	6173	
10	18214	
1	181699	

1. Typical performance.
2. Cycle time includes sweep and retrace time.

Table 20. Cycle time vs IF number of points¹ (Options 020, 025, 120, 125 only)

Applies to the preset condition (201 points, correction off) except for the following changes:

- CF = 10 GHz
 - Span = 100 MHz
 - Display off (add 21 ms for display on)

Description		Typical performance
IF Bandwidth (Hz)	Number of points	Cycle time (ms)²
30,000	3	6
	11	7
	51	6
	101	7
	201	11
	401	18
	801	32
	1,601	59
	6,401	224
	16,001	556
300,000	3	6
	11	6
	51	6
	101	7
	201	7
	401	9
	801	13
	1,601	22
	6,401	75
	16,001	180
600,000	3	6
	11	6
	51	6
	101	6
	201	7
	401	8
	801	9
	1,601	12
	6,401	27
	16,001	59

1. Typical performance.
2. Cycle time includes sweep and retrace time.

Table 21. Cycle time vs number of points¹ (Options 220, 225, 420, 425, 520, 525 only)

Applies to the preset condition (correction off) except for the following changes:

- CF = 10 GHz
- Span = 100 MHz
- Display off (add 21 ms for display on)

IF Bandwidth (Hz)	Number of points	Cycle time (ms) ²
30,000	3	8
	11	8
	51	9
	101	11
	201	15
	401	23
	801	39
	1,601	71
	6,401	265
	16,001	650
50,000	3	7
	11	7
	51	8
	101	10
	201	13
	401	18
	801	29
	1,601	52
	6,401	184
	16,001	448
250,000	101	8
	201	9
	401	10
	801	14
	1,601	21
	6,401	61
	16,001	147

Table 22. Data transfer time (ms)¹

	Number of points			
	201	401	1601	16,001
SCPI over GPIB (program executed on external PC)				
32-bit floating point	7	12	43	435
64-bit floating point	12	22	84	856
ASCII	64	124	489	5054
SCPI (program executed in the analyzer)				
32-bit floating point	1	2	3	30
64-bit floating point	2	2	4	40
ASCII	29	56	222	2220
COM (program executed in the analyzer)				
32-bit floating point	< 0.4	0.4	0.5	1.9
Variant type	0.7	1	3	32
DCOM over LAN (program executed on external PC)				
32-bit floating point	< 0.8	1	1.5	7.1
Variant type	1.8	2.7	8.5	80

1. Typical performance.

2. Cycle time includes sweep and retrace time.

Note: Specifications for recall and sweep speed are not provided for the N5230A analyzers.

Specifications: Front-Panel Jumpers

Model N5230A Option 025, 125, 225, 425, or 525

Note: The N5230A Option 020, 120, 220, 420, or 520 (standard test set and standard power range) has no front-panel jumpers.

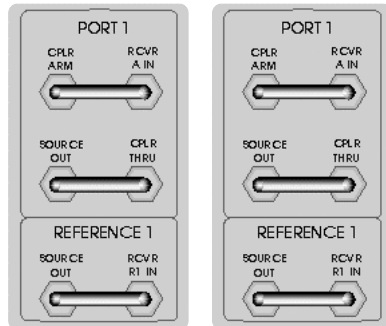

Table 23: Measurement receiver inputs (rcvr A In, rcvr B In)
0-1 dB Typical Compression

Description	Specification	Typicals		
		Option 025, 125	Option 225	Options 425, 525
Maximum input level				
300 kHz to 10 MHz		-11 dBm		
10 MHz to 45 MHz		-7 dBm	-2 dBm	-20 dBm
45 MHz to 500 MHz		-7 dBm	-2 dBm	-19 dBm
500 MHz to 2 GHz		-6 dBm	-3 dBm	-14 dBm
2 GHz to 12.5 GHz		-6 dBm	-6 dBm	-14 dBm
12.5 GHz to 13.5 GHz		-7 dBm	-6 dBm	-15 dBm
13.5 GHz to 20 GHz			-6 dBm	-15 dBm
20 GHz to 31.25 GHz				-16 dBm
31.25 GHz to 40 GHz				-21 dBm
40 GHz to 45 GHz				-24 dBm
45 GHz to 50 GHz				-22 dBm
Damage level				
N5230A		+15 dBm	+15 dBm	+15 dBm
Maximum DC level				
N5230A		±16 V	±7 V	±7 V

**Table 24: Reference receiver inputs (rcvr R1, rcvr R2)
at maximum specified output power**

Description	Specification	Typicals		
		Option 025, 125	Option 225	Options 425, 525
Maximum input level				
300 kHz to 10 MHz		-15 dBm		
10 MHz to 500 MHz		-13 dBm	-18 dBm	-28 dBm
500 MHz to 2 MHz		-14 dBm	-18 dBm	-28 dBm
2 GHz to 6 GHz		-14 dBm	-19 dBm	-28 dBm
6 GHz to 8 GHz		-16 dBm	-19 dBm	-28 dBm
8 GHz to 9 GHz		-16 dBm	-21 dBm	-27 dBm
9 GHz to 10.5 GHz		-20 dBm	-21 dBm	-27 dBm
10.5 GHz to 12.5 GHz		-22 dBm	-21 dBm	-27 dBm
12.5 GHz to 13.5 GHz		-24 dBm	-23 dBm	-26 dBm
13.5 GHz to 20 GHz			-23 dBm	-26 dBm
20 GHz to 31.25 GHz				-33 dBm
31.25 GHz to 40 GHz				-27 dBm
40 GHz to 45 GHz				-29 dBm
45 GHz to 50 GHz				-28 dBm
Damage level				
N5230A		+15 dBm	+15 dBm	+15 dBm
Maximum DC level				
N5230A		±16 V	±7 V	±7 V

**Table 25: Reference Outputs (reference 1 source out, reference 2 source out)
at maximum specified output power**

Description	Specification	Typicals		
		Option 025, 125	Option 225	Options 425, 525
Maximum output level				
300 kHz to 10 MHz		-15 dBm		
10 MHz to 500 MHz		-13 dBm	-18 dBm	-28 dBm
500 MHz to 2 GHz		-14 dBm	-18 dBm	-28 dBm
2 GHz to 6 GHz		-14 dBm	-19 dBm	-28 dBm
6 GHz to 8 GHz		-16 dBm	-19 dBm	-28 dBm
8 GHz to 9 GHz		-16 dBm	-20 dBm	-27 dBm
9 GHz to 10.5 GHz		-20 dBm	-20 dBm	-27 dBm
10.5 GHz to 12.5 GHz		-22 dBm	-20 dBm	-27 dBm
12.5 GHz to 13.5 GHz		-24 dBm	-23 dBm	-26 dBm
13.5 GHz to 20 GHz			-23 dBm	-26 dBm
20 GHz to 31.25 GHz				-32 dBm
31.25 GHz to 40 GHz				-26 dBm
40 GHz to 45 GHz				-29 dBm
45 GHz to 50 GHz				-28 dBm
Damage level				
N5230A		+20 dBm	+20 dBm	+20 dBm
Maximum DC level				
N5230A		±16 V	±7 V	±7 V

**Table 26: Source outputs (port 1 source out, port 2 source out)
at maximum specified output power**

Description	Specification	Typicals		
		Option 025, 125	Option 225	Options 425, 525
Maximum output level				
300 kHz to 10 MHz		+11 dBm		
10 MHz to 500 MHz		+11 dBm	+6 dBm	+1 dBm
500 MHz to 6 GHz		+11 dBm	+7 dBm	+1 dBm
6 GHz to 9 GHz		+10 dBm	+7 dBm	+1 dBm
9 GHz to 12.5 GHz		+8 dBm	+7 dBm	+1 dBm
12.5 GHz to 13.5 GHz		+5 dBm	+5 dBm	+3 dBm
13.5 GHz to 20 GHz			+5 dBm	+3 dBm
20 GHz to 31.25 GHz				-5 dBm
31.25 GHz to 40 GHz				-4 dBm
40 GHz to 45 GHz				-11 dBm
45 GHz to 50 GHz				-11 dBm
Damage level				
N5230A		+27 dBm	+30 dBm	+30 dBm
Maximum DC level				
N5230A		±16 V	±7 V	±7 V

Table 27: Coupler inputs (port 1 Cplr Thru, port 2 Cplr Thru)

Description	Specification	Typicals		
		Option 025, 125	Option 225	Options 425, 525
Insertion loss to test port				
30 kHz to 10 MHz		2 dB		
10 MHz to 500 MHz		2 dB	0.6 dB	0.6 dB
500 MHz to 2 GHz		3 dB	1.6 dB	0.8 dB
2 GHz to 8 GHz		3 dB	1.8 dB	1.0 dB
8 GHz to 9 GHz		3 dB	1.9 dB	1.0 dB
9 GHz to 12.5 GHz		4 dB	1.9 dB	1.0 dB
12.5 GHz to 13.5 GHz		4 dB	2.0 dB	2.0 dB
13.5 GHz to 20 GHz			2.0 dB	2.0 dB
20 GHz to 31.25 GHz				3.0 dB
31.25 GHz to 50 GHz				4.0 dB
Damage level				
N5230A		+27 dBm	+30 dBm	+30 dBm
Maximum DC level				
N5230A		±16 V	±40 V	±40 V

Table 28: Coupler outputs (port 1 Cplr Arm, port 2 Cplr Arm)

Description	Specification	Typicals		
		Option 025, 125	Option 225	Options 425, 525
Damage level				
N5250A		+15 dBm	+30 dBm	+30 dBm
Maximum DC level				
N5250A		+0 dBm	+30 dBm	+30 dBm

Test Set Block Diagrams

N5230A Option 020, 120, 220, 420, or 520

(standard test set and standard power range) network analyzer

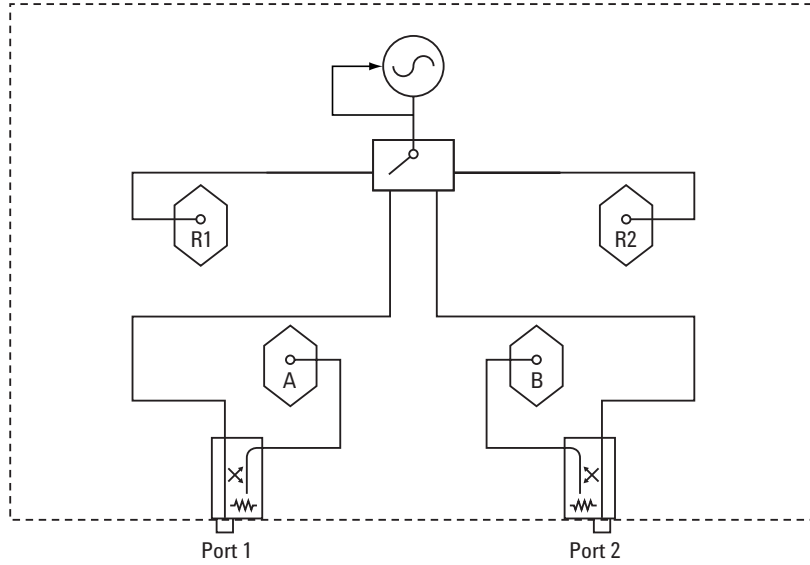

N5230A Option 025, 125, 225, 425, or 525

(configurable test set and extended power range) network analyzer

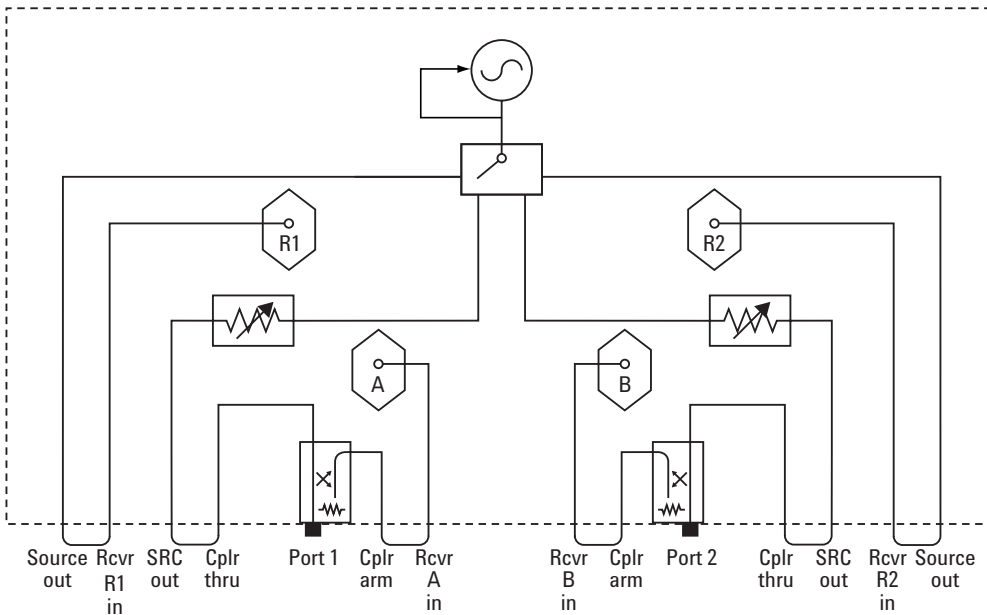

Web Resources

Visit our Web sites for additional product information and literature.

PNA Microwave network analyzers:
www.agilent.com/find/pna

PNA-L network analyzers:
www.agilent.com/find/pnal

Electronic calibration (ECal):
www.agilent.com/find/ecal

Test and measurement solutions:
www.agilent.com/find/accessories



Agilent Email Updates

www.agilent.com/find/emailupdates
Get the latest information on the products and applications you select.



Agilent Direct

www.agilent.com/find/agilentdirect
Quickly choose and use your test equipment solutions with confidence.

www.agilent.com

Agilent Technologies' Test and Measurement Support, Services, and Assistance

Agilent Technologies aims to maximize the value you receive, while minimizing your risk and problems. We strive to ensure that you get the test and measurement capabilities you paid for and obtain the support you need. Our extensive support resources and services can help you choose the right Agilent products for your applications and apply them successfully. Every instrument and system we sell has a global warranty. Two concepts underlie Agilent's overall support policy: "Our Promise" and "Your Advantage."

Our Promise

Our Promise means your Agilent test and measurement equipment will meet its advertised performance and functionality. When you are choosing new equipment, we will help you with product information, including realistic performance specifications and practical recommendations from experienced test engineers. When you receive your new Agilent equipment, we can help verify that it works properly and help with initial product operation.

Your Advantage

Your Advantage means that Agilent offers a wide range of additional expert test and measurement services, which you can purchase according to your unique technical and business needs. Solve problems efficiently and gain a competitive edge by contracting with us for calibration, extra-cost upgrades, out-of-warranty repairs, and onsite education and training, as well as design, system integration, project management, and other professional engineering services. Experienced Agilent engineers and technicians worldwide can help you maximize your productivity, optimize the return on investment of your Agilent instruments and systems, and obtain dependable measurement accuracy for the life of those products.



Agilent Open

www.agilent.com/find/open

Agilent Open simplifies the process of connecting and programming test systems to help engineers design, validate and manufacture electronic products. Agilent offers open connectivity for a broad range of system-ready instruments, open industry software, PC-standard I/O and global support, which are combined to more easily integrate test system development.

For more information on Agilent Technologies' products, applications or services, please contact your local Agilent office.

Phone or Fax

United States:

(tel) 800 829 4444
(fax) 800 829 4433

Canada:

(tel) 877 894 4414
(fax) 800 746 4866

China:

(tel) 800 810 0189
(fax) 800 820 2816

Europe:

(tel) 31 20 547 2111

Japan:

(tel) (81) 426 56 7832
(fax) (81) 426 56 7840

Korea:

(tel) (080) 769 0800
(fax) (080) 769 0900

Latin America:

(tel) (305) 269 7500

Taiwan:

(tel) 0800 047 866
(fax) 0800 286 331

Other Asia Pacific

Countries:

(tel) (65) 6375 8100
(fax) (65) 6755 0042

Email: tm_ap@agilent.com

Contacts revised: 05/27/05

The complete list is available at:
www.agilent.com/find/contactus

Product specifications and descriptions in this document subject to change without notice.

Intel® and Pentium® are US registered trademarks of Intel Corporation.

© Agilent Technologies, Inc. 2003 – 2005
Printed in USA, August 12, 2005
5989-0514EN



Agilent Technologies