

# FieldFox Handheld Analyzers

4/6.5/9/14/18/26.5/32/44/50 GHz

N9913A		
N9914A		
N9915A	N9925A	N9935A
N9916A	N9926A	N9936A
N9917A	N9927A	N9937A
N9918A	N9928A	N9938A
N9950A		N9960A
N9951A		N9961A
N9952A		N9962A



## Table of Contents

Definitions .....	3
Cable and Antenna Analyzer and Vector Network Analyzer .....	4
Corrected Measurement Uncertainty.....	14
TDR Cable Measurements (Option 215).....	21
VNA Time Domain (Option 010).....	22
Mixed-Mode S-Parameters (Option 212).....	22
Vector Voltmeter (VVM) (Option 308).....	23
Spectrum Analyzer (Option 233 on Combination Analyzers) .....	24
Tracking Generator or Independent Source .....	34
Real-Time Spectrum Analyzer (RTSA) (Option 350) .....	36
I/Q Analyzer (IQA) (Option 351).....	37
Noise Figure (NF) (Option 356).....	39
Spectrum Analyzer IF Output.....	44
Preamplifier (Option 235).....	45
Interference Analyzer and Spectrogram (Option 236).....	45
Channel Scanner (Option 312) .....	45
89600 VSA Software .....	45
Over-the-Air (OTA) LTE FDD (Option 370).....	46
Over-the-Air (OTA) 5GTF (Option 377) .....	47
AM/FM Analog demodulation, Tune and Listen (Option 355).....	49
Spectrum Analyzer Time Gating (Option 238).....	50
Reflection Measurements (RL, VSWR) (Option 320, applicable to SA only models) .....	50
Extended Range Transmission Analysis (ERTA) (Option 209) .....	51
Built-in Power Meter (Option 310).....	57
External USB Power Sensor Support (Option 302).....	58
Pulse Measurements (Option 330).....	58
USB Power Sensor Measurements versus Frequency (Option 208).....	58
Built-In GPS Receiver (Option 307).....	60
DC Bias Variable-Voltage Source (Option 309).....	60
Remote Control Capability (Option 030).....	61
General Information .....	61
FieldFox Physical Dimensions .....	65
Carry Precision With You.....	68

This data sheet provides the specified and typical performance of the FieldFox family of portable analyzers. This data sheet should be used in conjunction with the technical overviews and configuration guide, for a complete description of the analyzers.

The specifications and measurement capabilities listed in this document require certain options on the FieldFox analyzer. Refer to the FieldFox Configuration Guide to obtain option information. The configuration guide is the main resource for option/measurement capability information (<http://literature.cdn.keysight.com/litweb/pdf/5990-9836EN.pdf>).

## Definitions

### Specification (spec)

Specifications include guardbands to account for the expected statistical performance distribution, measurement uncertainties, and changes in performance due to environmental conditions. Specifications are warranted performance. FieldFox must be within its calibration cycle. No warm-up required for the specifications listed on pages 24 through 49.

### Typical

Describes additional product performance information not covered by the product warranty. It is performance beyond specifications that 80% of the units exhibit with a 90% confidence level over the temperature range  $23 \pm 5^{\circ}\text{C}$ , unless otherwise noted. Typical performance does not include measurement uncertainty. FieldFox must be within its calibration cycle.

### Nominal

A general, descriptive term or design parameter. It is not tested, and not covered by the product warranty. FieldFox must be within its calibration cycle.

## Cable and Antenna Analyzer and Vector Network Analyzer

The performance listed in this section applies to the cable and antenna analyzer (referred to as CAT) and vector network analyzer (VNA) capabilities available in the following models:

FieldFox RF & microwave (combination) analyzers:	N9913A, N9914A, N9915A, N9916A, N9917A, N9918A N9950A, N9951A, N9952A
FieldFox microwave vector network analyzers:	N9925A, N9926A, N9927A, N9928A

NOTE: Combination analyzers = Cable and antenna tester (CAT) + Vector network analyzer (VNA) + Spectrum analyzer (SA)

### Frequency specifications

	Models	Frequency range
N991xA, N992xA	N9913A	30 kHz to 4 GHz
	N9914A	30 kHz to 6.5 GHz
	N9915A, N9925A	30 kHz to 9 GHz
	N9916A, N9926A	30 kHz to 14 GHz
	N9917A, N9927A	30 kHz to 18 GHz
	N9918A, N9928A	30 kHz to 26.5 GHz
N995xA	N9950A	300 kHz to 32 GHz
	N9951A	300 kHz to 44 GHz
	N9952A	300 kHz to 50 GHz
<b>Frequency reference, -10 to 55°C</b>		
Accuracy	± 0.7 ppm (spec) + aging	
	± 0.4 ppm (typical) + aging	
Accuracy, when locked to GPS	± 0.010 ppm (spec)	
Accuracy, when GPS antenna is disconnected	± 0.2 ppm (nominal) <sup>1</sup>	
Aging Rate	± 1 ppm/yr for 20 years (spec), will not exceed ± 3.5 ppm	
<b>Frequency resolution</b>	<b>Spec</b>	
Frequency ≤ 5 GHz	1 Hz	
Frequency ≤ 10 GHz	1.34 Hz	
Frequency ≤ 20 GHz	2.68 Hz	
Frequency ≤ 40 GHz	5.36 Hz	
Frequency ≤ 50 GHz	8.04 Hz	
<b>Data points or resolution</b>		
101, 201, 401, 601, 801, 1001, 1601, 4001, 10,001 Arbitrary number of points settable through front panel and SCPI		
<b>IF bandwidth<sup>2</sup></b>		
3 Hz, 10 Hz, 30 Hz, 100 Hz, 300 Hz, 1 kHz, 3 kHz, 10 kHz, 30 kHz, 100 kHz		
<b>System impedance</b>		
50 Ω (nominal), 75 Ω with appropriate adapter and calibration kit		

<sup>1</sup> The maximum drift expected in the frequency reference applicable when the ambient temperature changes ±5°C from the temperature when the GPS signal was last connected.

<sup>2</sup> VNA mode only. Recommend using averaging in CAT mode.

## Cable and Antenna Analyzer and Vector Network Analyzer (continued)

### Test port output specifications

**High power** in N991xA and N992xA refers to the target output power level of the analyzer when the *Power Setting* is set to *High*. As an example, if you have a frequency sweep from 3 to 6.5 GHz, the analyzer will achieve the power level of -1 dBm across the band.

**Low power** level for N991xA and N992xA analyzers is a flat -45 dBm across the whole frequency band and is the output of the analyzer when the *Power Setting* is set to *Low*.

**High power** in the N995xA refers to the target output power level of the analyzer when the *Power Setting* is set to *High*. As an example, if you have a frequency sweep from 39 to 46 GHz, the analyzer will achieve the power level of -2 dBm across the band.

**Low power** level for N995xA analyzers is the lowest power level that can be set and is the output of the analyzer when the *Power Setting* is set to *Low*.

**Max leveled power** in the N995xA refers to the maximum leveled (flattened) power that can be achieved across the designated frequency range. For example, if you have a frequency sweep from 32 to 44 GHz and set up the analyzer to measure all four S-parameters, needing both ports 1 and 2, the maximum power the analyzer can be set to is -6 dBm.

Test port output power (dBm), high power	Typical	Nominal
<b>N991xA, N992xA</b>	<b>Port 1 or Port 2</b>	<b>Port 1 or Port 2</b>
30 to 300 kHz	-11	—
> 300 kHz to 2 MHz	-3	-2
> 2 to 625 MHz	-2	-1
> 625 MHz to 3 GHz	1	3
> 3 to 6.5 GHz	-1	1
> 6.5 to 9 GHz	-2	0
> 9 to 14 GHz	-4	-2.5
> 14 to 18 GHz	-6	-4.5
> 18 to 23 GHz	-10	-8.5
> 23 to 26.5 GHz	-12	-11
Test port output power (dBm), low power	Typical	Nominal
<b>N991xA, N992xA</b>	<b>Port 1 or Port 2</b>	<b>Port 1 or Port 2</b>
30 kHz to 26.5 GHz	—	-45 (flattened)

## Cable and Antenna Analyzer and Vector Network Analyzer (continued)

### Test port output specifications (continued)

Test port output power (dBm), high power		Typical		Nominal
N995xA		Port 1	Port 2	
300 kHz to 2 MHz		0	0	—
> 2 MHz to 1 GHz		2	2	—
> 1 to 6.5 GHz		2	0	—
> 6.5 to 18 GHz		4	1	—
> 18 to 39 GHz		1	-2	—
> 39 to 46 GHz		-2	-5	—
> 46 to 50 GHz		-4	-7	—
Test port output power (dBm), low power		Typical		Nominal
N995xA		Port 1	Port 2	
500 kHz to 10 MHz		-35	-38	—
> 10 MHz to 10 GHz		-38	-42	—
> 10 to 20 GHz		-43	-47	—
> 20 to 44 GHz		-44	-50	—
> 44 to 50 GHz		-53	-55	—
Max leveled output power (dBm)		Typical		Nominal
N995xA		Port 1	Port 2	
500 kHz to 10 MHz		-2	-2	—
> 10 MHz to 25 GHz		0	0	—
> 25 to 32 GHz		0	-4	—
> 32 to 44 GHz		-3	-6	—
> 44 to 50 GHz		-7	-10	—
Output power range				
CAT		High, low, and manual. Default (preset) power is high. Manual power is flattened.		
VNA		High, low, and manual. Default (preset) power is manual, -15 dBm. Manual power is flattened.		
Power step size				
		Power settable in 1 dB steps across power range. Flat power, in 1 dB steps, is available across the whole frequency span, nominal.		
Power level accuracy <sup>1</sup>		Typical		
N991xA, N992xA		± 1.5 dB at -15 dBm, for frequencies > 250 kHz		
N995xA		± 0.7 dB at -15 dBm, for frequencies > 500 kHz to 10 MHz ± 0.5 dB at -15 dBm, for frequencies > 10 MHz to 50 GHz		
Power level linearity		Nominal		
N995xA		Port 1 or Port 2, -25 dBm ≤ P < max leveled power		
10 MHz to 50 GHz		± 0.5 dB		

<sup>1</sup> N991xA and N992xA power levels are calibrated in the factory using a broadband power sensor, which means all tones (fundamental and harmonics) are included. N995xA power levels are calibrated based on PNA-X's tuned receiver, which means primarily the fundamental is included (for frequencies ≥ 10 MHz).

## Cable and Antenna Analyzer and Vector Network Analyzer (continued)

### System performance specifications

System dynamic range <sup>1,2</sup> (dB), high power, 300 Hz IFBW, 100 point average, Port 1 or Port 2 (-10 to 55°C)			
	Frequency	Spec	Typical
N991xA, N992xA	> 300 kHz to 9 GHz <sup>3</sup>	95	100
	> 9 to 14 GHz	91	97
	> 14 to 18 GHz	90	94
	> 18 to 20 GHz	87	90
	> 20 to 25 GHz	74	79
	> 25 to 26.5 GHz	65	70
N995xA	> 300 kHz to 1 MHz	—	70 (nominal)
	> 1 to 10 MHz	—	100 (nominal)
	> 10 MHz to 20 GHz <sup>4</sup>	100	110
	> 20 to 44 GHz <sup>5</sup>	90	100
	> 44 to 50 GHz <sup>6</sup>	81	90
Measurement stability over temperature		Nominal	
	Frequency	Magnitude (dB/°C)	Phase (deg/°C)
N991xA, N992xA	≤ 15 GHz	± 0.018	—
	> 15 to 26.5 GHz	± 0.080	—
N995xA	≤ 15 GHz	± 0.005	± 0.1
	≤ 25 GHz	± 0.030	± 0.3
	> 25 GHz	± 0.060	± 0.6
Measurement speed (Sweep time)			
CAT		N991xA, N992xA	N995xA
	Return loss, 30 kHz to 26.5 GHz, 1-port cal, 1001 points <sup>7</sup>	673 μs /pt	—
	Return loss, 300 kHz to 50 GHz, 1-port cal, 1001 points	—	686 μs /pt
	Distance-to-fault, 100-meter cable, 1-port cal, 1001 points <sup>7</sup>	782 μs /pt	760 μs /pt
VNA		N991xA, N992xA	N995xA
	S11 and S21, 30 kHz to 26.5 GHz, enhanced response cal, 100 kHz IF bandwidth, 1001 points <sup>8</sup>	432 μs /pt	—
	S11 and S21, 300 kHz to 50 GHz, enhanced response cal, 100 kHz IF bandwidth, 1001 points	—	478 μs /pt

<sup>1</sup> System dynamic range is measured in the factory with loads on the test ports after a thru normalization.

<sup>2</sup> For CAT mode, "Insertion loss (2-port)", decrease listed dynamic range specifications by 20 dB, as CAT mode IFBW is fixed at 10 kHz. Can obtain full dynamic range by using S21 measurement in VNA mode with 100 Hz IFBW.

<sup>3</sup> < 300 kHz: 63 dB nominal; 2 to 9 MHz: 85 dB spec, 90 dB typical.

<sup>4</sup> Decrease by 3 dB from 15 to 15.8 GHz for S21.

<sup>5</sup> Decrease by 5 dB from 21.7 to 22.1 GHz for S21.

<sup>6</sup> Decrease by 4 dB from 44 to 50 GHz for S21.

<sup>7</sup> 850 μs /pt; slower speed applicable to FieldFox models with serial number prefix ≤ MY5607/SG5607/US5607 and FieldFox models not upgraded with the fast CPU Option N9910HU-100/200/300.

<sup>8</sup> 850 μs /pt; slower speed applicable to FieldFox models with serial number prefix ≤ MY5607/SG5607/US5607 and FieldFox models not upgraded with the fast CPU Option N9910HU-100/200/300.

## Cable and Antenna Analyzer and Vector Network Analyzer (continued)

### Test port input specifications

Trace noise <sup>1</sup> , high power, 300 Hz IFBW, Port 1 or Port 2		Spec (-10 to 55°C)	
	Frequency	Magnitude (dB rms)	Phase (deg rms)
N991xA, N992xA, N995xA	> 300 kHz to 20 GHz <sup>2</sup>	0.004	0.07
	> 20 to 26.5 GHz	0.007	0.14
	> 26.5 to 30 GHz	0.007	0.14
	> 30 to 50 GHz	0.008	0.22
Receiver compression		Typical	
	Frequency	Port 1 or Port 2	
N991xA, N992xA	500 MHz to 1 GHz	+10 dBm, 0.15 dB compression	
	> 1 to 26.5 GHz	+10 dBm, 0.10 dB compression	
N995xA	2 MHz to 50 GHz	+5 dBm, 0.10 dB compression	
Maximum input level		Port 1 or Port 2	
	Average CW power	DC	
N991xA, N992xA	+27 dBm, 0.5 watts	± 50 VDC	
N995xA	+25 dBm, 0.3 watts	± 40 VDC	
Immunity to interfering signals		Nominal	
		+16 dBm	

### CAT and VNA measurements

CAT mode	
CAT measurements	Distance-to-fault (dB) Return loss (dB) Return loss and DTF (dB) VSWR Distance-to-fault (VSWR) Cable loss (1-port) Insertion loss (2-port) (requires option 211) Distance-to-fault (Lin) TDR (Lin rho) (requires option 215) TDR (ohm) (requires option 215) TDR & DTF (requires option 215)
Distance-to-fault (DTF) settings	
Frequency/distance	Start distance, stop distance
Sweep time	Units: meters or feet (Can also be set as Preferences)
Frequency mode	Bandpass, lowpass
CAT mode averaging	Set sweep time in seconds

<sup>1</sup> For CAT mode, increase trace noise by a factor of 5.7, as CAT mode IFBW is fixed at 10 kHz. Can use averaging in CAT mode to reduce trace noise or use VNA mode with 300 Hz IFBW.

<sup>2</sup> Excludes multiples of 390 kHz.



## Cable and Antenna Analyzer and Vector Network Analyzer (continued)

### CAT and VNA measurements (continued)

<b>CAT mode</b>	
Distance-to-fault	Available in CAT mode. Standard on N991xA and N995x analyzers. Option 305 on N992xA analyzers Range = velocity factor x speed of light x (number of points -1) / frequency span x 2 Number of points auto coupled according to start and stop distance entered. Resolution = range / (number of points -1) Transform modes: Bandpass, low-pass Window types: Maximum, medium, and minimum Alias free range indicator: On/Off Dispersion compensation for waveguide: Yes
Return loss, log magnitude	-500 to 500 dB
Log magnitude resolution	0.01 dB
VSWR	1.01 to 1000
VSWR resolution	0.01
<b>VNA mode</b>	
VNA Transmission/Reflection (T/R)	S11, S21 magnitude and phase (requires option 210)
VNA S-parameters	S11, S21, S22, S12 magnitude and phase (requires options 210 and 211)
Number of traces	Four traces available: Tr1, Tr2, Tr3, Tr4
Display formats	Single-trace Dual-trace split (each trace on separate graticule) Dual-trace overlay (both traces on one graticule) Three-trace split (each trace on separate graticule) Three-trace overlay (all three traces on one graticule) Quad-trace split (each trace on separate graticule) Quad-trace overlay (all four traces on one graticule)
VNA trace formats	Log magnitude, linear magnitude, VSWR, phase, Smith chart, polar, group delay, unwrapped phase, real impedance, imaginary impedance, Z magnitude
Frequency settings	Start, stop, center, span
Frequency sweep type	Linear
Sweep type trigger	Continuous, single
Sweep trigger source	Internal, external, point (point trigger applies to 1-port cal only)
Sweep trigger slope	Positive, negative
Sweep trigger delay	0 to 10 seconds
Averaging	Sweep averaging: 2 to 1000
Smoothing	Computes the moving average of adjacent data points. Smoothing aperture defines the trace width (number of points) to be averaged. Minimum aperture: 0.05% of frequency span Maximum aperture: 25% of frequency span
Scale	Autoscale, scale, reference level, reference position Autoscale: Automatically selects scale resolution and reference value to center the trace. Autoscale all: Scales all visible traces.

## Cable and Antenna Analyzer and Vector Network Analyzer (continued)

### CAT and VNA measurements (continued)

<b>VNA mode</b>	
S11, log magnitude	-500 to 500 dB
Log magnitude resolution	0.01 dB
VSWR	1.01 to 1000
VSWR resolution	0.01
Phase	-180 to +180 degrees (unwrapped phase can show larger values)
Phase resolution	0.01 degrees
Phase offset	-360 to +360 degrees
Magnitude offset	-100 to +100 dB
Trace math	Vector division or subtraction of current linear measurement values and memory data
Port extension	For both port 1 and port 2, delay settings. Port extensions apply to all measurements.
Marker formats	Default marker format is the trace format. Other formats: R + jX Z magnitude Phase Real Imaginary Mag & Phase dB Angle
<b>General CAT / VNA modes</b>	
Marker functions	Peak, Next Peak, Peak Left, Peak Right, Mkr→Center, Mkr→Delay, Min Search, Peak Excursion, Peak Threshold, Target, Bandwidth (BW, Q, Loss), Tracking CAT mode only: Tracking 3 peaks (CAT mode), Marker→Start distance, Marker→Stop distance
Marker table	On/Off
Marker types	Normal, delta, data trace and memory trace markers
Marker coupling	On/Off (coupling between traces)
Frequency blanking	Security level: none, high. If high, all frequency information is blanked out. An instrument preset is required to re-enable the frequency information.
Display data	Display data, memory, data and memory, or data math
Trace math	One memory trace per data trace.

## Cable and Antenna Analyzer and Vector Network Analyzer (continued)

### CAT and VNA mode calibrations

FieldFox analyzers offer three tiers of calibrations, thus providing users with different levels of calibration effort and accuracy.

#### CalReady

CalReady is the most basic calibration and is sufficient for a quick pass/fail or go/no go verification. Every FieldFox is calibrated at the factory, at test ports 1 and 2, at room temperature. CalReady can be applied either as an “enhanced response CalReady” or a “2-port CalReady.” The default setting is 2-port CalReady, so correction is applied to both ports. A user preference allows user to change the CalReady methodology to enhanced response CalReady.

A 30-minute warm-up period is recommended for a quick test. A 90-minute warm-up is necessary for more stringent test requirements.

If CalReady is the basis for most measurements, the annual cal cycle must be followed, as the CalReady calibration will be updated during the annual cal cycle.

#### QuickCal

QuickCal is the next level of calibration. QuickCal uses internal standards and a subset of external standards and builds on the factory-created CalReady. Users can perform QuickCal with a load or without a load. A QuickCal calibration with a load yields a more accurate measurement.

Important note: QuickCal is most accurate for DUTs with 7/16 and Type-N connectors and measurement uncertainties are provided for frequencies  $\leq 18$  GHz. Accuracy is reduced for DUTs with 3.5 mm (m), SMA (m), or other male coaxial connectors; performance is unspecified. QuickCal is not recommended for DUTs with 3.5 mm (f), SMA (f), or other similar female connectors. QuickCal is not applicable to waveguide.

A 60-minute warm-up period is recommended.

If QuickCal is the basis for most measurements, it is highly recommended that the annual cal cycle be followed, as QuickCal builds on CalReady and CalReady data are updated during the annual cal cycle.

## Cable and Antenna Analyzer and Vector Network Analyzer (continued)

### Standard calibrations

Standard calibrations are the most accurate calibrations offered in FieldFox. FieldFox's calibration engine is based on Keysight's flagship PNA calibration engine, and as such, offers many of the standard calibrations. FieldFox supports both coaxial and waveguide calibrations. The table below lists the commonly used calibrations.

A 60-minute warm-up period is recommended for standard calibrations. For ultimate in stability and accuracy, a 90-minute warm-up period is necessary.

<b>Frequency response</b> <b>Open response</b> <b>Short response</b> <b>Thru response</b> <b>With and without isolation</b>	Simultaneous magnitude and phase correction of frequency response errors for either reflection or transmission measurements. Isolation corrects for crosstalk errors.
<b>1-port OSL (Port 1)</b> <b>1-port OSL (Port 2)</b>	Open, short, and load Traditional 1-port calibration for reflection measurements. Corrects for directivity, source match, and frequency response errors.
<b>SSL (for waveguide)</b>	For waveguide calibrations, depending on the calibration kit definition, this is presented as a short, offset short and load calibration.
<b>Enhanced response (also known as one-path, two-port)</b> <b>Forward enhanced response</b> <b>Reverse enhanced response</b>	Corrects for frequency response and source match. Partial correction for load match for low-loss reciprocal devices.
<b>QSOLT (2-port)</b>	QSOLT or Quick short-open-load-thru is FieldFox's default recommended calibration for insertable devices. Full 12-term error correction. Requires fewer connections, compared to traditional SOLT (4 compared to 7). Corrects for directivity, source match, reflection frequency response, load match, and transmission frequency response.
<b>Full 2-port (unknown thru calibration)</b>	FieldFox's default recommended calibration for non-insertable devices. Full 12-term error correction. Beneficial for characterizing non-insertable devices such as Type-N to 3.5 mm, or female-female devices. Corrects for directivity, source match, reflection frequency response, load match, and transmission frequency response.
<b>TRL</b>	TRL or thru-reflect-line compensates for directivity, reflection, and transmission frequency response in both the forward and reverse directions.

\*\* Note: FieldFox does not offer the traditional SOLT calibration. Instead, it offers the more accurate Full 2-port (unknown thru), and also QSOLT.

### ECal

FieldFox supports all Keysight USB ECal modules, both standard and value-line ECals.

### FieldFox's Guided Calibration Wizard

FieldFox's calibration wizard recommends a calibration type and calibration kit based on selected parameters and connector types. Alternatively, users can select their own calibration type and calibration kit. FieldFox's calibration wizard ensures a valid calibration selection.

## Cable and Antenna Analyzer and Vector Network Analyzer (continued)

### Interpolation Error Correction

With any type of accuracy enhancement applied, interpolated mode recalculates the error coefficients when the test frequencies are changed. The number of points can be increased or decreased, and the start/stop frequencies can be changed, but the resulting frequency span must be a subset of the original calibration frequency span.

### Connectors

The following connector types are included by default with the FieldFox firmware. Additional connector types can be added by adding a new calibration kit that is based on the new connector type.

Coaxial	Waveguide
Type-N 50 ohm	WR-10
Type-N 75 ohm	WR-15
7/16	WR-22
TNC	WR-28
Type-F	WR-42
7 mm	WR-62
3.5 mm	WR-75
2.4 mm	WR-90
2.92 mm	WR-112
	WR-137
	WR-187
	WR-284
	WR-650

### FieldFox S-parameter measurement uncertainty charts

This data sheet includes measurement uncertainty charts for the configurations listed in the table below. Additional uncertainty charts are available in the secondary data sheet 5992-1926EN.

FieldFox model	Calibration Kit	Calibration Type	DUT Connector	Uncertainty
N9913/4/5/6/7/8A & N9925/6/7/8A	—	QuickCal	Type-N(m)	Nominal
N9913/4/5/6/7/8A & N9925/6/7/8A	85518A or 85519A	Full 2-port calibration	Type-N	Spec
N9913/4/5/6/7/8A & N9925/6/7/8A	85054D	Full 2-port calibration	Type-N	Spec
NN9913/4/5/6/7/8A & N9925/6/7/8A	85520A or 85521A	Full 2-port calibration	3.5 mm	Spec
N9913/4/5/6/7/8A & N9925/6/7/8A	85052D	Full 2-port calibration	3.5 mm	Spec
N9950/1/2A	85056D	Full 2-port calibration	2.4 mm	Spec
N9950/1/2A	N4693A ECal	Full 2-port calibration	2.4 mm	Spec

# Corrected Measurement Uncertainty

## N9913/4/5/6/7/8A and N9925/6/7/8A, QuickCal, DUT: Type-N(m), Nominal<sup>1</sup>

Power level of -15 dBm, 10 Hz IF bandwidth, no averaging, battery saver off, and 30-minute warm-up time. Includes uncertainties due to drift, noise, compression, and dynamic accuracy. Coverage factor of x1 applied to uncertainties, for ease of comparison with other industry handheld analyzers.

### Transmission uncertainty (S21, S12)

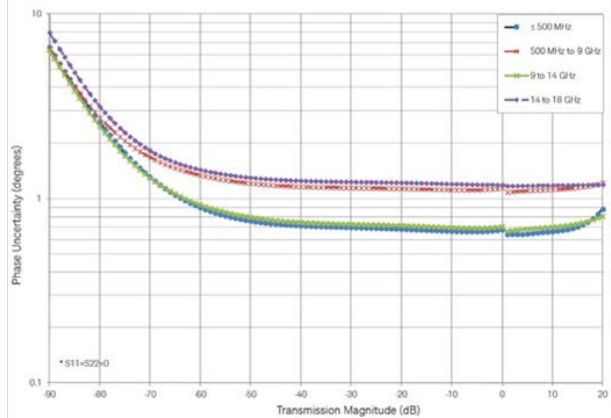
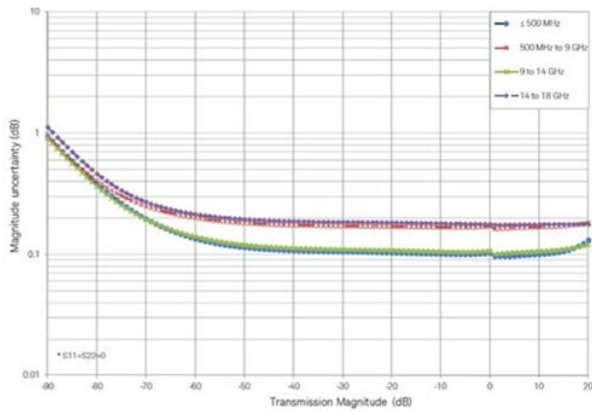

### Reflection uncertainty (S11, S22)

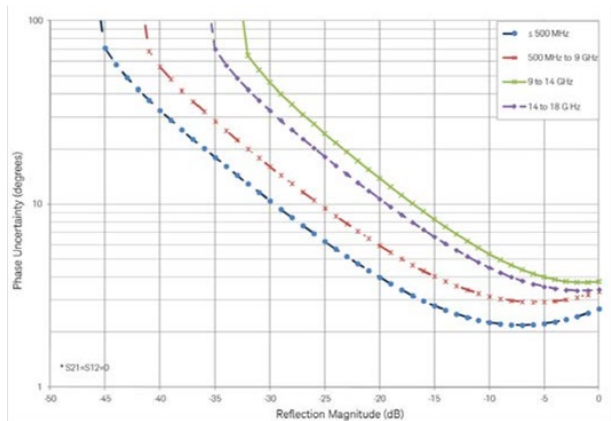
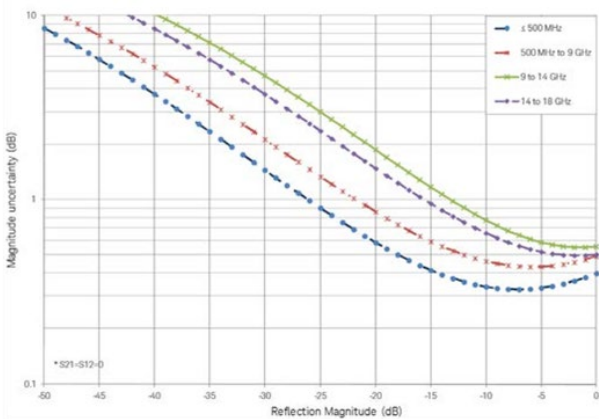

<sup>1</sup> Uncertainties shown based on a factory calibration using data-based calibration kits.

## Corrected Measurement Uncertainty (continued)

### N9913/4/5/6/7/8A and N9925/6/7/8A, 85518A or 85519A, Full 2-port Cal, DUT: Type-N, Spec

Power level of -15 dBm, 10 Hz IF bandwidth, no averaging, battery saver off, and 60-minute warm-up time. Includes uncertainties due to drift, noise, compression, and dynamic accuracy. Coverage factor of x1 applied to uncertainties, for ease of comparison with other industry handheld analyzers.

Corrected performance (dB)	0.2 to 500 MHz <sup>1</sup>	0.5 to 2 GHz	2 to 9 GHz	9 to 18 GHz
Directivity	44	42	35	32
Source match	37	36	33	30
Load match	37	36	33	30
Reflection tracking	± 0.050	± 0.060	± 0.070	± 0.100
Transmission tracking	± 0.050	± 0.060	± 0.070	± 0.100

### Transmission uncertainty (S21, S12)

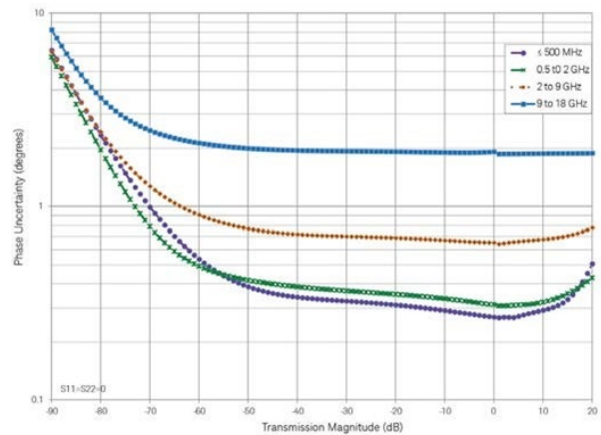
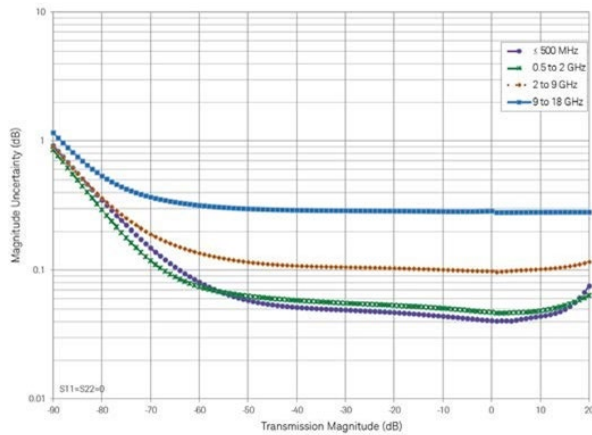

### Reflection uncertainty (S11, S22)

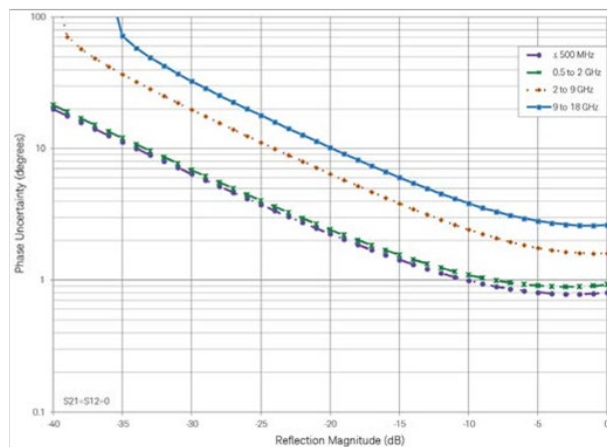
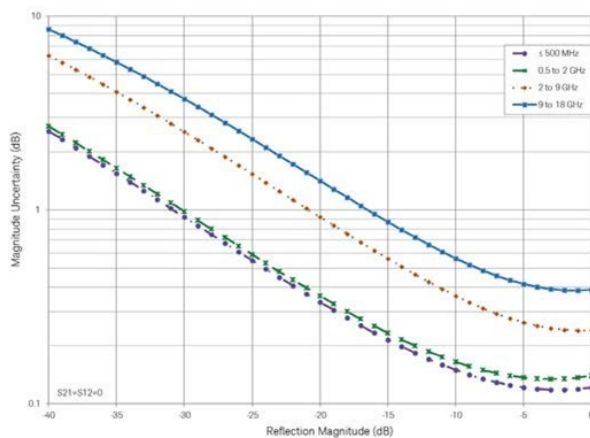

<sup>1</sup> Start frequency of 200 kHz applies to measurement uncertainty charts.

## Corrected Measurement Uncertainty (continued)

### N9913/4/5/6/7/8A and N9925/6/7/8A, 85054D, Full 2-port Cal, DUT: Type-N, Spec

Power level of -15 dBm, 10 Hz IF bandwidth, no averaging, battery saver off, and 60-minute warm-up time. Includes uncertainties due to drift, noise, compression, and dynamic accuracy. Coverage factor of x1 applied to uncertainties, for ease of comparison with other industry handheld analyzers.

Corrected performance (dB)	0.2 to 500 MHz <sup>1</sup>	0.5 to 2 GHz	2 to 8 GHz	8 to 18 GHz
Directivity	40	40	36	34
Source match	38	33	33	27
Load match	38	33	33	27
Reflection tracking	± 0.006	± 0.006	± 0.009	± 0.027
Transmission tracking	± 0.006	± 0.006	± 0.009	± 0.027

### Transmission uncertainty (S21, S12)

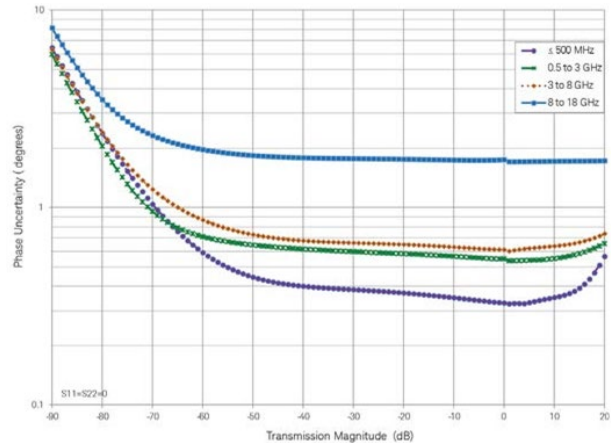
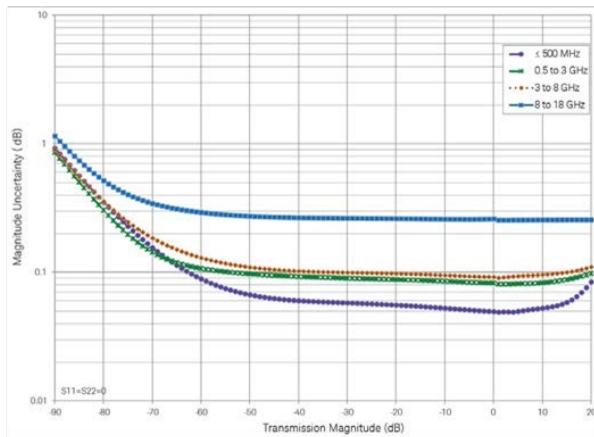

### Reflection uncertainty (S11, S22)

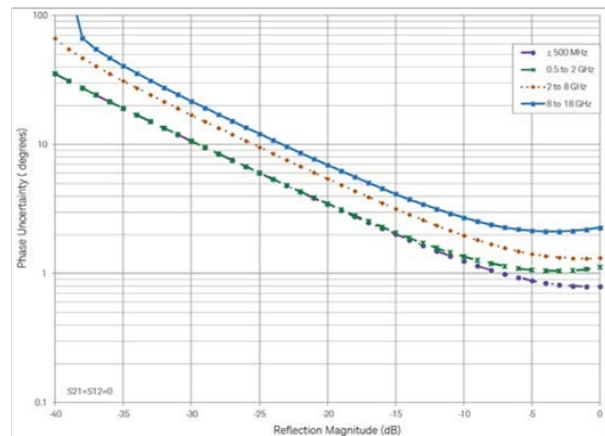
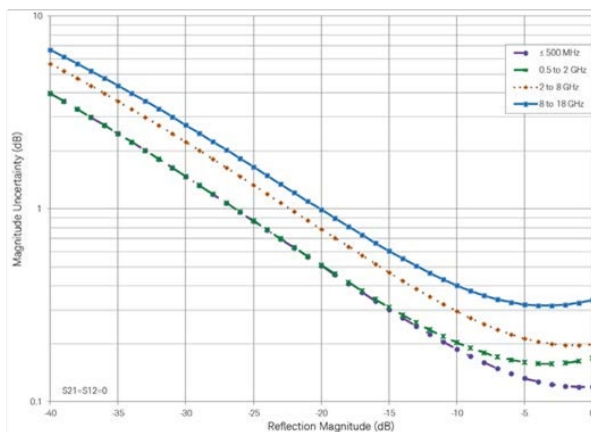

<sup>1</sup> Start frequency of 200 kHz applies to measurement uncertainty charts.



## Corrected Measurement Uncertainty (continued)

### N9913/4/5/6/7/8A and N9925/6/7/8A, 85520A or 85521A, Full 2-port Cal, DUT: 3.5 mm, Spec

Power level of -15 dBm, 10 Hz IF bandwidth, no averaging, battery saver off, and 60-minute warm-up time. Includes uncertainties due to drift, noise, compression, and dynamic accuracy. Coverage factor of x1 applied to uncertainties, for ease of comparison with other industry handheld analyzers.

Corrected performance (dB)	0.2 to 500 MHz <sup>1</sup>	0.5 to 9 GHz	9 to 18 GHz	18 to 26.5 GHz
Directivity	42	36	32	32
Source match	37	30	28	27
Load match	37	30	28	27
Reflection tracking	± 0.035	± 0.130	± 0.140	± 0.210
Transmission tracking	± 0.035	± 0.130	± 0.140	± 0.210

### Transmission uncertainty (S<sub>21</sub>, S<sub>12</sub>)

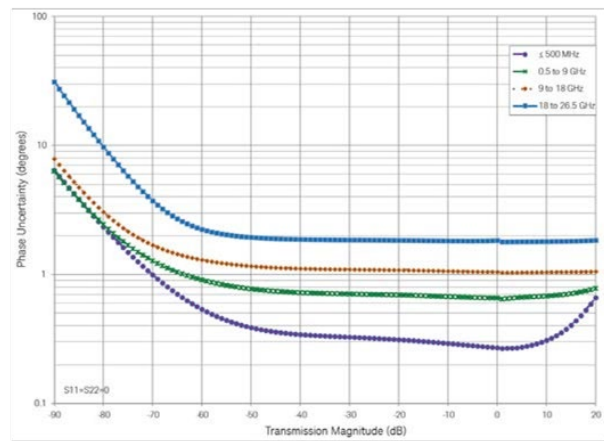
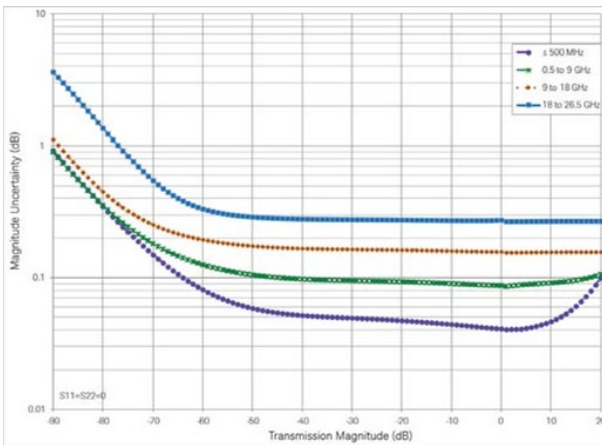

### Reflection uncertainty (S<sub>11</sub>, S<sub>22</sub>)

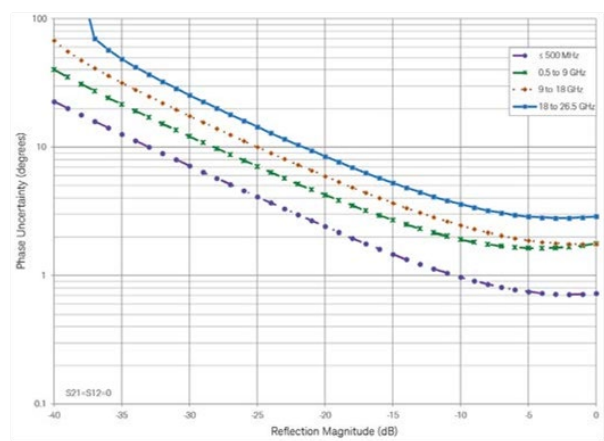
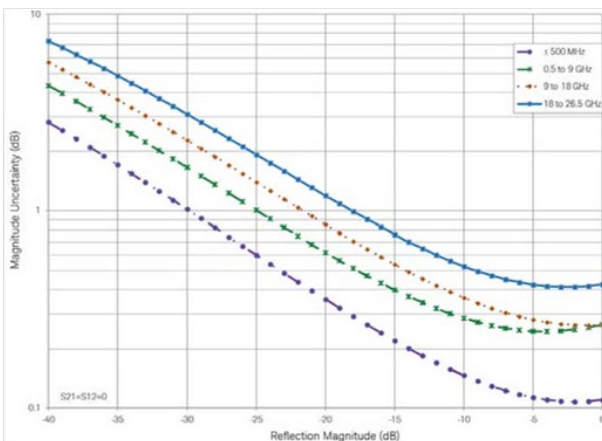

<sup>1</sup> Start frequency of 200 kHz applies to measurement uncertainty charts.

## Corrected Measurement Uncertainty (continued)

### N9913/4/5/6/7/8A and N9925/6/7/8A, 85052D, Full 2-port Cal, DUT: 3.5 mm, Spec

Power level of -15 dBm, 10 Hz IF bandwidth, no averaging, battery saver off, and 60-minute warm-up time. Includes uncertainties due to drift, noise, compression, and dynamic accuracy. Coverage factor of x1 applied to uncertainties, for ease of comparison with other industry handheld analyzers.

Corrected performance (dB)	0.2 to 500 MHz <sup>1</sup>	0.5 to 8 GHz	8 to 20 GHz	20 to 26.5 GHz
Directivity	42	38	36	30
Source match	37	31	28	25
Load match	37	31	28	25
Reflection tracking	± 0.005	± 0.006	± 0.009	± 0.012
Transmission tracking	± 0.005	± 0.006	± 0.009	± 0.012

### Transmission uncertainty (S<sub>21</sub>, S<sub>12</sub>)

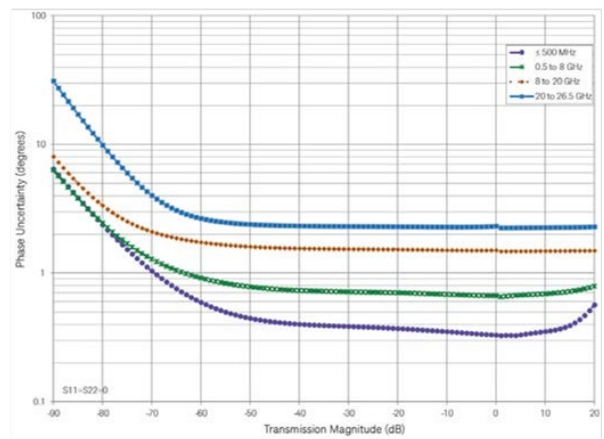
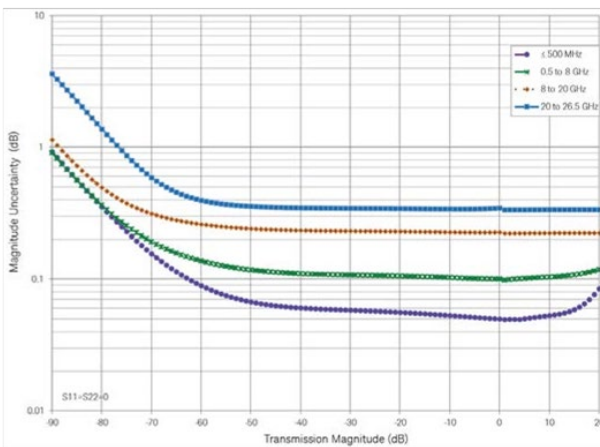

### Reflection uncertainty (S<sub>11</sub>, S<sub>22</sub>)

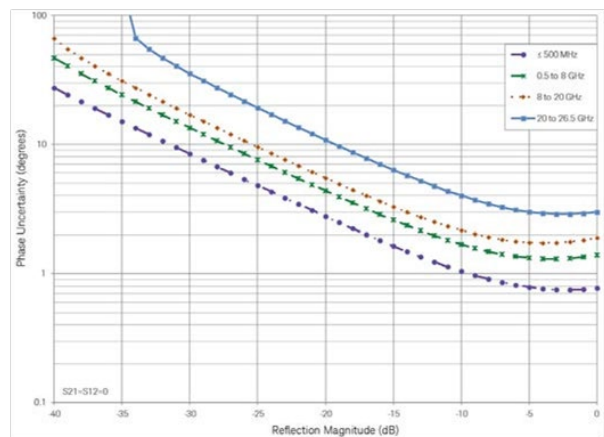
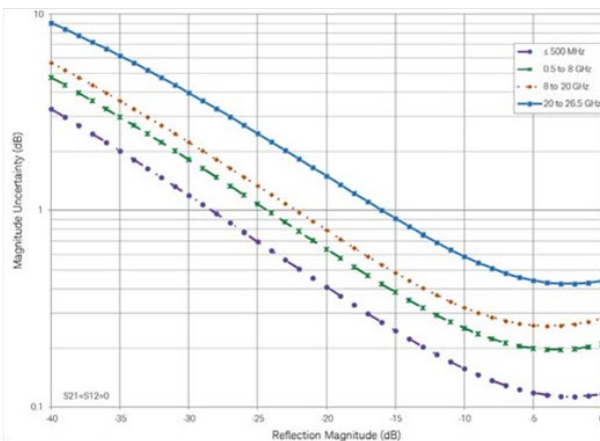

<sup>1</sup> Start frequency of 200 kHz applies to measurement uncertainty charts.

## Corrected Measurement Uncertainty (continued)

N9950/1/2A, 85056D, Full 2-port Cal, DUT: 2.4 mm, Spec<sup>1</sup>

Power level of -15 dBm, 10 Hz IF bandwidth, no averaging, battery saver off, and 60-minute warm-up time. Includes uncertainties due to drift, noise, compression, and dynamic accuracy. Coverage factor of x1 applied to uncertainties, for ease of comparison with other industry handheld analyzers.

Corrected performance (dB)	≤ 2 GHz	2 to 20 GHz	20 to 40 GHz	40 to 50 GHz
Directivity	42	34	26	26
Source match	39	30	23	23
Load match	39	30	23	23
Reflection tracking	± 0.002	± 0.029	± 0.080	± 0.075
Transmission tracking	± 0.002	± 0.029	± 0.080	± 0.075

### Transmission uncertainty (S<sub>21</sub>, S<sub>12</sub>)

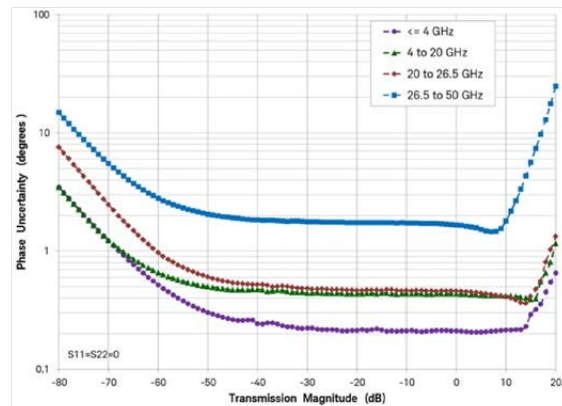
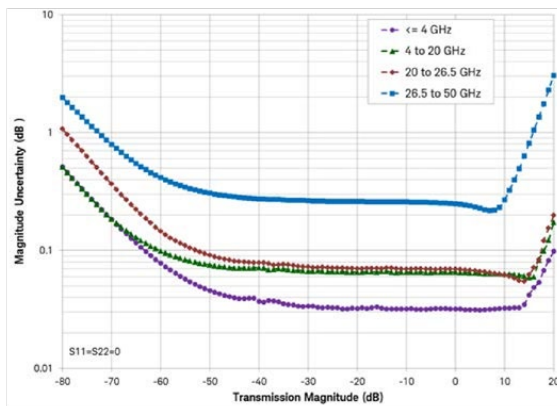

### Reflection uncertainty (S<sub>11</sub>, S<sub>22</sub>)

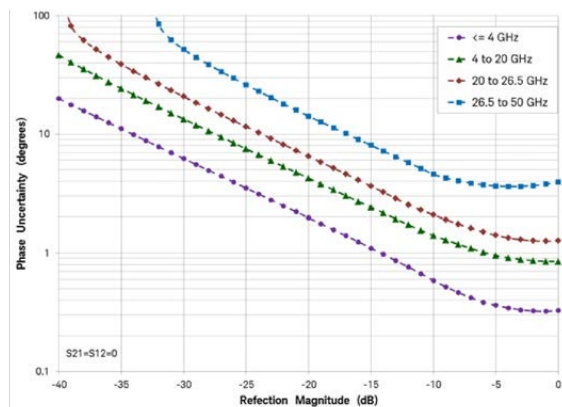
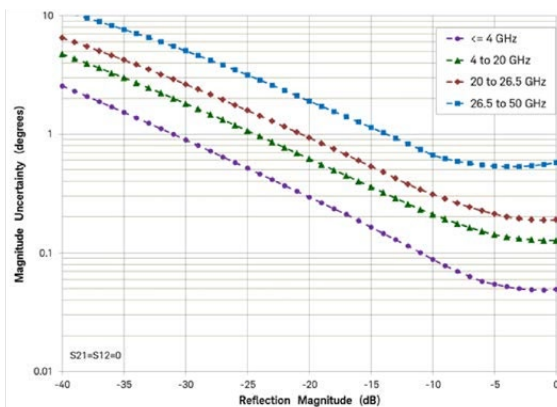

<sup>1</sup> Uncertainty curves shown are calculated based on ISO GUM methodology. The values in the table are provided for reference only, in accordance to legacy uncertainty methods.

## Corrected Measurement Uncertainty (continued)

### N9950/1/2A, N4693A ECal, Full 2-port Cal, DUT: 2.4 mm, Spec<sup>1</sup>

Power level of -15 dBm, 10 Hz IF bandwidth, no averaging, battery saver off, and 60-minute warm-up time. Includes uncertainties due to drift, noise, compression, and dynamic accuracy. Coverage factor of x1 applied to uncertainties, for ease of comparison with other industry handheld analyzers.

Corrected performance (dB)	10 to 50 MHz	50 MHz to 2 GHz	2 to 10 GHz	10 to 20 GHz	20 to 40 GHz	40 to 50 GHz
Directivity	32	42	49	45	41	36
Source match	25	44	42	37	35	32
Load match	25	44	42	37	35	32
Reflection tracking	± 0.050	± 0.030	± 0.040	± 0.050	± 0.060	± 0.080
Transmission tracking	± 0.050	± 0.030	± 0.040	± 0.050	± 0.060	± 0.080

### Transmission uncertainty (S<sub>21</sub>, S<sub>12</sub>)

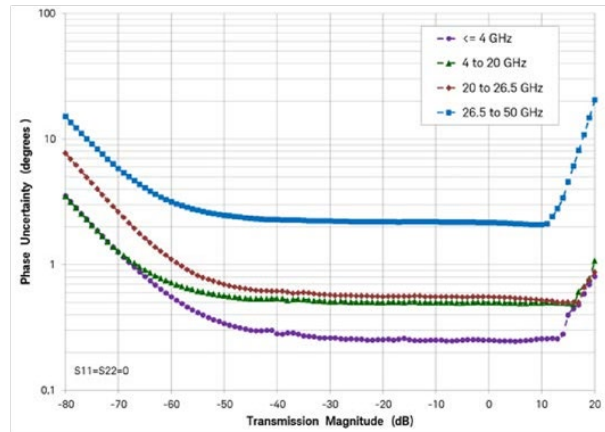
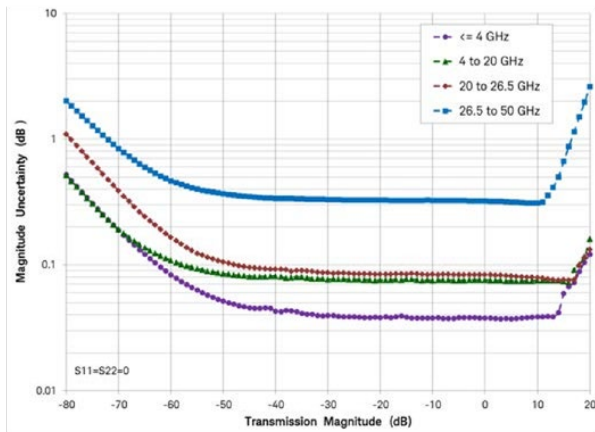

### Reflection uncertainty (S<sub>11</sub>, S<sub>22</sub>)

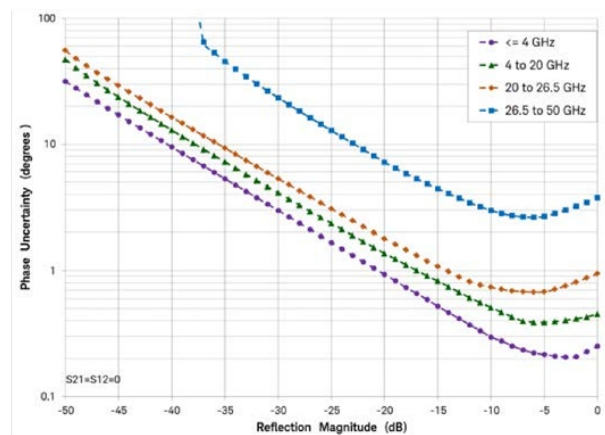
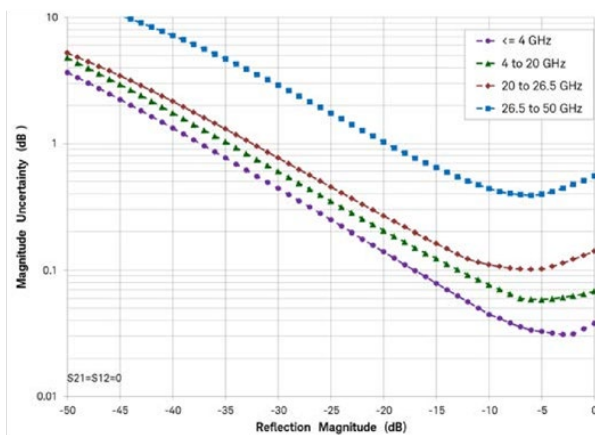

<sup>1</sup> Uncertainty curves shown are calculated based on ISO GUM methodology. The values in the table are provided for reference only, in accordance to legacy uncertainty methods.

The performance listed in TDR cable measurements, VNA time domain, mixed-mode S-parameters and vector voltmeter sections applies to the capabilities available in the following models:

FieldFox RF & microwave (combination) analyzers:	N9913A, N9914A, N9915A, N9916A, N9917A, N9918A N9950A, N9951A, N9952A
FieldFox microwave vector network analyzers:	N9925A, N9926A, N9927A, N9928A

See [FieldFox Configuration Guide](#) for option information. Many capabilities listed in this Data Sheet require options.

## TDR Cable Measurements (Option 215)

The TDR cable option adds time domain reflectometry (TDR) measurements to FieldFox's CAT mode. FieldFox's TDR measurements are based on an inverse Fourier transform of the frequency-domain data. TDR measurements are useful in not only identifying the location of faults along cables, but also the nature of the fault. Resistive, inductive and capacitive faults will each have a different response. These differences help engineers and technicians trouble-shoot line faults.

Measurements: TDR (linear rho), TDR (ohm), TDR & DTF

Y-axis: linear (rho) or impedance (ohm)

X-axis: distance (meters or feet)

## VNA Time Domain (Option 010)

In time-domain mode, FieldFox computes the inverse Fourier transform of the frequency-domain data to display reflection or transmission coefficients versus time.

Setup parameters	
Time	Start, stop, center, span
Gating	Start, stop, center, span, and on/off
Numbers of points, velocity vector, line loss, window shape, independent control for all four traces	
Time stimulus modes	
Low-pass step	Low-pass step is similar to a traditional time domain reflectometer (TDR) stimulus waveform. It is used to measure low-pass devices. The frequency-domain data should extend from DC (extrapolated value) to a higher value.
Low-pass impulse	Low-pass impulse response is used to measure low-pass devices.
Bandpass impulse	The bandpass impulse simulates a pulsed RF signal and is used to measure the time domain response of band-limited devices.
Windows	
The windowing function can be used to filter the frequency domain data and thereby reduce overshoot and ringing in the time domain response.	
Windows	Minimum, medium and maximum, manual entry of Kaiser Beta and impulse width.
Gating	
The gating function can be used to selectively remove reflection or transmission time domain responses. In converting back to the frequency domain, the effects of the responses outside the gate are removed. The results can be viewed with gating on and off, using two traces.	
Gate types	Notch, bandpass
Gate shapes	Maximum, wide, normal, minimum

## Mixed-Mode S-Parameters (Option 212)

Mixed-mode S-parameters are also known as balanced measurements.

Measurements	
Scc11	Common mode reflection
Sdd11	Differential mode reflection
Scd11	Differential mode stimulus, common mode response
Sdc11	Common mode stimulus, differential mode response

FieldFox's mixed-mode S-parameter measurements require the use of the default factory calibration or a user 2-port calibration. So, the FieldFox analyzer must be equipped with 2-port measurement functionality to measure mixed-mode S-parameters. Mixed-mode S-parameters are an extension of the VNA capabilities.

## Vector Voltmeter (VVM) (Option 308)

With vector voltmeter mode, you can characterize the difference between two measurements easily. The zeroing function allows you to create a reference signal and characterize the difference between two device measurements. The results are shown on a large display in digital format.

	Models	Frequency range
N991xA, N992xA	N9913A	30 kHz to 4 GHz
	N9914A	30 kHz to 6.5 GHz
	N9915A, N9925A	30 kHz to 9 GHz
	N9916A, N9926A	30 kHz to 14 GHz
	N9917A, N9927A	30 kHz to 18 GHz
	N9918A, N9928A	30 kHz to 26.5 GHz
N995xA	N9950A	300 kHz to 32 GHz
	N9951A	300 kHz to 44 GHz
	N9952A	300 kHz to 50 GHz
Setup parameters		
1-port cable trimming	Reflection (S11 or S22 measurement), magnitude and phase	
2-port transmission	Transmission or S21 measurement, magnitude and phase	
A/B and B/A	Ratio of two receivers or channels, magnitude and phase – Need an external signal generator for the A/B or B/A measurement	
	Frequency (one CW frequency point)	
	IF bandwidth: 10 Hz to 100 kHz or 3 Hz to 30 kHz	
	Output power: Low, high, manual	

### Ratio accuracy (A/B and B/A)

Must zero before measuring DUT. Recommend using a high-quality power splitter or 6 dB attenuators to minimize uncertainty due to mismatch.

	Frequency	Nominal (dB)
N991xA, N992xA, N995xA	100 to 300 kHz <sup>1</sup>	± 1.0
	> 300 kHz to 1 MHz	± 0.4
	> 1 to 100 MHz	± 0.2
	> 100 to 300 MHz	± 0.4
	> 300 MHz to 1.5 GHz	± 0.6
	> 1.5 to 2 GHz	± 1.0

<sup>1</sup> Does not apply to N995xA models, which start at 300 kHz.

## Spectrum Analyzer (Option 233 on Combination Analyzers)

The performance listed in this section applies to the spectrum analyzer capabilities available in the following models:

FieldFox RF & microwave (combination) analyzers:	N9913A, N9914A, N9915A, N9916A, N9917A, N9918A N9950A, N9951A, N9952A
FieldFox microwave spectrum analyzers:	N9935A, N9936A, N9937A, N9938A N9960A, N9961A, N9962A

See [FieldFox Configuration Guide](#) for option information. Many capabilities listed in this Data Sheet require options.

### Frequency and time specifications

	Models	Frequency range <sup>1</sup>	
N991xA, N993xA	N9913A	100 kHz to 4 GHz	Usable to 5 kHz
	N9914A	100 kHz to 6.5 GHz	Usable to 5 kHz
	N9915A, N9935A	100 kHz to 9 GHz	Usable to 5 kHz
	N9916A, N9936A	100 kHz to 14 GHz	Usable to 5 kHz
	N9917A, N9937A	100 kHz to 18 GHz	Usable to 5 kHz
	N9918A, N9938A	100 kHz to 26.5 GHz	Usable to 5 kHz
N995xA, N996xA	N9950A, N9960A	9 kHz to 32 GHz	Usable to 5 kHz
	N9951A, N9961A	9 kHz to 44 GHz	Usable to 5 kHz
	N9952A, N9962A	9 kHz to 50 GHz	Usable to 5 kHz

#### Frequency reference, -10 to 55°C

Accuracy	± 0.7 ppm (spec) + aging ± 0.4 ppm (typical) + aging
Accuracy, when locked to GPS	± 0.01 ppm (spec)
Accuracy, when GPS antenna is disconnected	± 0.2 ppm (nominal) <sup>2</sup>
Aging rate	± 1 ppm/yr for 20 years (spec), will not exceed ± 3.5 ppm

#### Frequency readout accuracy (start, stop, center, marker)

± (readout frequency x frequency reference accuracy + RBW centering + 0.5 x horizontal resolution)	Horizontal resolution = frequency span / (trace points – 1) RBW centering:
	<ul style="list-style-type: none"> <li>• 5% x RBW, FFT mode (nominal)</li> <li>• 16% x RBW, step mode (nominal)</li> </ul>

#### Marker frequency counter

Accuracy	± (marker frequency x frequency reference accuracy + counter resolution)
Resolution	1 Hz

<sup>1</sup> The spectrum analyzer is tunable to 0 Hz or DC.

<sup>2</sup> The maximum drift expected in the frequency reference applicable when the ambient temperature changes ± 5°C from the temperature when the GPS signal was last connected.



## Spectrum Analyzer (Option 233 on Combination Analyzers) (continued)

### Frequency and time specifications (continued)

Frequency Span	Spec	
Range	0 Hz (zero span), 10 Hz to maximum frequency range of instrument	
Resolution	1 Hz	
Accuracy	± (2 x RBW centering + horizontal resolution) for detector = Normal	
Sweep time readout	Measured value of the time required to complete a sweep from start to finish, including time to tune receiver, acquire data, and process trace.	
Trace update, nominal	N991xA, N993xA	N995xA, N996xA
Span = 20 MHz, RBW, VBW = 3 kHz	6.7 updates per second <sup>1</sup>	8 updates per second
Span = 100 MHz, RBW, VBW autocoupled	15.4 updates per second <sup>2</sup>	19 updates per second
Center frequency tune and transfer <sup>3</sup>	N991xA, N993xA <sup>4</sup>	N995xA, N996xA
101 points, zero span	70 ms	69 ms
101 points, 1 MHz span	72 ms	72 ms
Sweep time, zero span	Nominal	
Range	N991xA, N993xA: 1 µs to 1000 s N995xA, N996xA: 1 µs to 6000 s	
Resolution	100 ns	
Readout	Entered value representing trace horizontal scale range	
Trigger (for zero span and FFT sweeps)		
Trigger type	Free run, external, video, RF burst	
Trigger slope	Positive edge, negative edge	
Trigger delay	Range: -150 ms to 10 s Resolution: 100 ns	
Auto trigger	Forces a periodic acquisition in the absence of a trigger event Range: 0 (off) to 30 s	
Trigger position (zero span)	Controls horizontal position of the pulse edge; use sweep time to zoom into pulse edge Range: 0 to 10, integer steps; 0 is left edge of graticule, 10 is right edge of graticule	
RF burst trigger	Nominal	
Dynamic range	40 dB	
Bandwidth	20 MHz	
Operating frequency range	20 MHz to maximum instrument frequency	
Sweep (trace) point range		
All spans	101, 201, 401, 601, 801, 1001 (defaults to 401); Arbitrary 2 to 20,001 settable through soft key "# Points" or SCPI	

<sup>1</sup> 1.2 updates per second; applicable to FieldFox units with serial number prefix ≤ MY5607/SG5607/US5607 and FieldFox units not upgraded with the fast CPU Option N9910HU-100/200/300.

<sup>2</sup> 4.1 updates per second; applicable to FieldFox units with serial number prefix ≤ MY5607/SG5607/US5607 and FieldFox units not upgraded with the fast CPU Option N9910HU-100/200/300.

<sup>3</sup> Within full frequency range of instrument, not band dependent

<sup>4</sup> Applicable to FieldFox units with serial number prefix ≥ MY5607/SG5607/US5607 and FieldFox units that have been upgraded with the fast CPU Option N9910HU-100/200/300.

## Spectrum Analyzer (Option 233 on Combination Analyzers) (continued)

### Frequency and time specifications (continued)

Resolution bandwidth (RBW)	Nominal	
Range (-3 dB bandwidth)		
Zero span	10 Hz to 5 MHz	1, 3, 10 sequence
Non-zero span	1 Hz to 5 MHz	1, 1.5, 2, 3, 5, 7.5, 10 sequence < 300 kHz, 300 kHz, 1 MHz, 3 MHz, 5 MHz (Other RBW's may be set depending on settings)
		Step keys change RBW in 1, 3, 10 sequence
Selectivity (-60 dB / -3 dB)	4:1	
Bandwidth accuracy	Nominal	
Zero span	10 Hz to 1 MHz	± 5%
	3 MHz	± 10%
	5 MHz	± 15%
Non-zero span	1 Hz to 100 kHz	± 1%
	300 kHz to 1 MHz	± 5%
	3 MHz	± 10%
	5 MHz	± 15%
Video bandwidth (VBW)	1 Hz to 5 MHz	1, 1.5, 2, 3, 5, 7.5, 10 sequence

### Amplitude accuracy and range specifications

Amplitude range		
Measurement range	DANL to +20 dBm	
Input attenuator range	0 to 30 dB, in 5 dB steps	
Preamplifier	Nominal	
Frequency range	Full band (100 kHz to maximum frequency of instrument)	
Gain	N991xA, N993xA	+20 dB, 100 kHz to 26.5 GHz
	N995xA, N996xA	+20 dB, 100 kHz to 7.5 GHz +15 dB, > 7.5 to 50 GHz
Max safe input level	Average CW power	DC
N991xA, N993xA	+27 dBm, 0.5 watts	± 50 VDC
N995xA, N996xA	+25 dBm, 0.3 watts	± 40 VDC
Display range		
Log scale	10 divisions	
	0.01 to 100 dB/division in 0.01 dB steps	
Linear scale	10 divisions	
Scale units	dBm, dBmV, dBμV, dBmA, dBμA, W, V, A, dBμV/m, dBμA/m, dBG, dBT	

## Spectrum Analyzer (continued)

### Amplitude accuracy and range specifications (continued)

<b>50 MHz absolute amplitude accuracy (dB)</b>				
0 dB attenuation, input signal 0 to -35 dBm, peak detector, preamplifier off, 300 Hz RBW, all settings auto-coupled. No warm-up required.				
	Spec (-10 to 55°C)	Typical (-10 to 55°C)		
N991xA, N993xA	± 0.30	± 0.10		
0 dB attenuation, input signal -5 to -35 dBm, peak detector, preamplifier off, 300 Hz RBW, all settings auto-coupled. No warm-up required.				
	Spec (-10 to 55°C)	Typical (-10 to 55°C)		
N995xA, N996xA	± 0.45	± 0.20		
<b>Total absolute amplitude accuracy (dB)</b>				
10 dB attenuation, input signal -15 to -5 dBm, peak detector, preamplifier off, 300 Hz RBW, all settings auto-coupled, includes frequency response uncertainties. No warm-up required.				
N991xA, N993xA <sup>1</sup>	Spec (23 ± 5°C)	Spec (-10 to 55°C)	Typical (23 ± 5°C)	Typical (-10 to 55°C)
100 kHz to 18 GHz	± 0.80	± 1.00	± 0.35	± 0.50
> 18 to 26.5 GHz	± 1.00	± 1.20	± 0.50	± 0.60
<b>Total absolute amplitude accuracy (dB)</b>				
10 dB attenuation, input signal -15 to -5 dBm, peak detector, preamplifier off, 300 Hz RBW, all settings auto-coupled, includes frequency response uncertainties. No warm-up required.				
N995xA, N996xA <sup>2</sup>	Spec (23 ± 5°C)	Spec (-10 to 55°C)	Typical (23 ± 5°C)	Typical (-10 to 55°C)
9 to 100 kHz	± 1.60	± 2.50	± 0.60	± 1.30
> 100 kHz to 2 MHz	± 1.30	± 1.90	± 0.60	± 0.80
> 2 to 15 MHz	± 1.00	± 1.20	± 0.30	± 0.50
> 15 MHz to 32 GHz	± 0.80	± 1.00 <sup>3</sup>	± 0.30	± 0.50
> 32 to 40 GHz	± 0.90	± 1.40	± 0.50	± 0.70
> 40 to 43 GHz	± 1.30	± 2.00	± 0.50	± 0.70
> 43 to 50 GHz	± 1.40	± 2.70	± 0.50	± 0.90
<b>Resolution bandwidth switching uncertainty</b>		<b>Nominal</b>		
RBW < 5 MHz		0.0 dB		
For signals not at center frequency		0.7 dB peak-to-peak		

<sup>1</sup> 9 to 100 kHz: 0.4 dB (nominal) preamp on or off; applicable only for serial number with prefix of MY5607/SG5607/US5607 and FieldFox upgraded with Option N9910HU-100/200/300/400.

<sup>2</sup> For N995xA and N996xA models, for frequencies > 100 kHz, absolute amplitude accuracy specifications apply to not only preamplifier off, but also preamplifier on.

<sup>3</sup> Increase by 0.2 dB between 18 and 32 GHz.

## Spectrum Analyzer (continued)

### Amplitude accuracy and range specifications (continued)

RF input VSWR		Nominal
N991xA, N993xA (10 dB attenuation)	10 MHz to 2.7 GHz	1.7 : 1
	> 2.7 to 7.5 GHz	1.5 : 1
	> 7.5 to 26.5 GHz	2.2 : 1
N995xA, N996xA (0 dB attenuation)	10 to 100 MHz	2.0 : 1
	> 100 to 500 MHz	1.7 : 1
	> 500 MHz to 17 GHz	1.5 : 1
	> 17 to 50 GHz	2.2 : 1
Reference level		
Range	-210 to +90 dBm	
Traces		
Detectors	Normal, positive peak, negative peak, sample, average (RMS)	
States	Clear/write, max hold, min hold, average, view, blank	
	Number of averages: 1 to 10,001	
Number	4: all four can be active simultaneously and in different states	
Markers		
Number of markers	6	
Type	Normal, delta, marker table	
Marker functions	Noise, band power, frequency counter	
Audio beep	Volume and tone change with signal strength	
Marker table	Display 6 markers	
Marker to →	Peak, next peak, peak left, peak right, center frequency, reference level, minimum	
	Tune frequency, for AM/FM tune and listen	
Marker properties	Peak criteria: peak excursion, peak threshold	
	Delta reference fixed: Off or On	
	Time zero fixed: Off or On	

## Spectrum Analyzer (continued)

### Dynamic range specifications

<b>Displayed average noise level (DANL) - (dBm)</b>				
Input terminated, RMS detection, log averaging, 0 dB input attenuation, reference level of -20 dBm, normalized to 1 Hz RBW, measured at non-zero frequency span				
<b>N991xA, N993xA<sup>1</sup></b>				
<b>Preamp off</b>	<b>Spec (23 ± 5°C)</b>	<b>Spec (-10 to 55°C)</b>	<b>Typical (23 ± 5°C)</b>	<b>Typical (-10 to 55°C)</b>
2 MHz to 4.5 GHz <sup>2</sup>	-137	-135	-139	-138
> 4.5 to 7 GHz	-133	-131	-136	-130
> 7 to 13 GHz	-129	-127	-132	-130
> 13 to 17 GHz	-124	-122	-126	-125
> 17 to 22 GHz	-119	-117	-122	-121
> 22 to 25 GHz	-114	-111	-117	-114
> 25 to 26.5 GHz	-110	-108	-112	-111
<b>Preamp on</b>	<b>Spec (23 ± 5°C)</b>	<b>Spec (-10 to 55°C)</b>	<b>Typical (23 ± 5°C)</b>	<b>Typical (-10 to 55°C)</b>
2 MHz to 4.5 GHz <sup>3,2</sup>	-153	-151	-155	-154
> 4.5 to 7 GHz	-149	-147	-151	-150
> 7 to 13 GHz	-147	-145	-149	-148
> 13 to 17 GHz	-143	-141	-145	-144
> 17 to 22 GHz	-140	-139	-143	-142
> 22 to 25 GHz	-134	-132	-137	-134
> 25 to 26.5 GHz	-128	-126	-131	-129
<b>N995xA, N996xA</b>				
<b>Preamp off</b>	<b>Spec (23 ± 5°C)</b>	<b>Spec (-10 to 55°C)</b>	<b>Typical (23 ± 5°C)</b>	<b>Typical (-10 to 55°C)</b>
9 kHz to 2 MHz	-91	-91	-118	-118
> 2 MHz to 2.1 GHz	-137	-135	-143	-141
> 2.1 to 2.8 GHz	-135	-133	-142	-140
> 2.8 to 4.5 GHz	-137	-135	-143	-141
> 4.5 to 7 GHz	-134	-133	-140	-138
> 7 to 13 GHz	-134	-132	-141	-139
> 13 to 22 GHz	-132	-129	-140	-137
> 22 to 35 GHz	-130	-127	-137	-134
> 35 to 40 GHz	-122	-119	-132	-129
> 40 to 46 GHz	-119	-116	-126	-123
> 46 to 50 GHz	-117	-112	-124	-120

<sup>1</sup> 9 kHz to 2 MHz: -116 (nominal) preamp off, -120 (nominal) preamp on, applicable only for FieldFox units with serial number prefixes of MY5607/SG5607/US5607 and FieldFox units upgraded with Option N9910HU-100/200/300/400.

<sup>2</sup> Add 4 dB between 2.1 and 2.8 GHz.

## Spectrum Analyzer (continued)

### Dynamic range specifications (continued)

N995xA, N996xA				
Preamp on	Spec (23 ± 5°C)	Spec (-10 to 55°C)	Typical (23 ± 5°C)	Typical (-10 to 55°C)
9 kHz to 2 MHz	-94	-94	-131	-130
> 2 MHz to 2.1 GHz	-153	-151	-159	-158
> 2.1 to 2.8 GHz	-151	-149	-157	-155
> 2.8 to 4.5 GHz	-153	-151	-158	-156
> 4.5 to 7 GHz	-150	-149	-156	-154
> 7 to 13 GHz	-146	-144	-152	-150
> 13 to 22 GHz	-142	-139	-149	-147
> 22 to 35 GHz	-141	-139	-147	-145
> 35 to 40 GHz	-136	-132	-144	-141
> 40 to 46 GHz	-131	-128	-138	-135
> 46 to 50 GHz	-126	-123	-135	-132

Residual responses (dBm)	Nominal	
	N991xA, N993xA	N995xA, N996xA
Input terminated preamp off, 0 dB attenuation		
100 kHz to 10 MHz	-90	—
> 10 MHz to 13 GHz	-110	—
> 13 GHz to 20 GHz	-90	—
> 20 GHz to 26.5 GHz	-80	—
100 kHz to 10 MHz	—	-90
> 10 MHz to 1 GHz <sup>1</sup>	—	-110
> 1 GHz to 32 GHz <sup>2</sup>	—	-100
> 32 GHz to 50 GHz	—	-95

Input related responses (dBc)	Nominal	
	N991xA, N993xA	N995xA, N996xA
-30 dBm signal at mixer input (excludes frequencies listed below)	-80	-80
f = center frequency		
< 2.6 GHz, f + 2 x 33.75 MHz	-80	-80
< 2.6 GHz, f - 2 x 866.25 MHz	-80	-80
< 2.6 GHz, f + 2 x 3.63375 GHz	-85	-90
≥ 2.6 to 7.5 GHz, f + 2 x 33.75 MHz	-80	-80
≥ 2.6 to 7.5 GHz, f + 2 x 866.25 MHz	-80	-80
≥ 2.6 to 7.5 GHz, f + 2 x 9.86625 GHz	-80	-85
≥ 7.5 to 16.3 GHz, f + 2 x 3.63375 GHz	-65	-65
≥ 16.3 to 26.5 GHz, f - 2 x 3.63375 GHz	-60	—
≥ 7.5 to 26.5 GHz, f + 2 x 33.75 MHz	-80	—
≥ 7.5 to 26.5 GHz, f - 2 x 866.25 MHz	-80	—
≥ 16.3 to 23 GHz, f - 2 x 3.63375 GHz	—	-60
≥ 23 to 32.5 GHz, f + 2 x 3.63375 GHz	—	-65
≥ 32.5 to 43 GHz, f - 2 x 3.63375 GHz	—	-55
≥ 7.5 to 50 GHz, f - 2 x 866.25 MHz	—	-80
≥ 7.5 to 50 GHz, f + 2 x 33.75 MHz	—	-80

<sup>1</sup> Excludes 90 MHz @ -95 dBm

<sup>2</sup> Excludes 25.43 GHz @ -90 dBm

## Spectrum Analyzer (continued)

### Dynamic range specifications (continued)

Other spurious responses (dBc)		Nominal
	N991xA, N993xA	N995xA, N996xA
LO related spurs	-60	-60
Sideband	-80	-80
Second harmonic distortion (dBc)		Nominal
	N991xA, N993xA	N995xA, N996xA
-30 dBm signal at mixer input		
≤ 1.3 GHz <sup>1</sup>	—	< -75
> 1.3 GHz	—	< -60
≤ 4 GHz <sup>1</sup>	< -60	—
> 4 GHz	< -80	—
Third order intermodulation distortion (TOI) – (dBm)		Typical
Two -15 dBm signals, 100 kHz spacing at mixer input (-10 to 55°C)		
N991xA, N993xA		< 1 GHz, +10
		1 to 7.5 GHz, +15
		> 7.5 GHz, +21
N995xA, N996xA		50 to 500 MHz, +9.5
		> 500 MHz to 1 GHz, +13
		> 1 to 2.4 GHz, +16
		> 2.4 to 2.6 GHz, +12
		> 2.6 GHz, +13
Spur free dynamic range (dB) at 2.4 GHz 2/3 (TOI – DANL) in 1 Hz RBW		Nominal
N991xA, N993xA		>105
N995xA, N996xA		>104

<sup>1</sup> Applies to frequencies > 15 MHz

## Distortion and noise limited (10 Hz RBW) dynamic range (nominal)

Applies to N991xA and N993xA

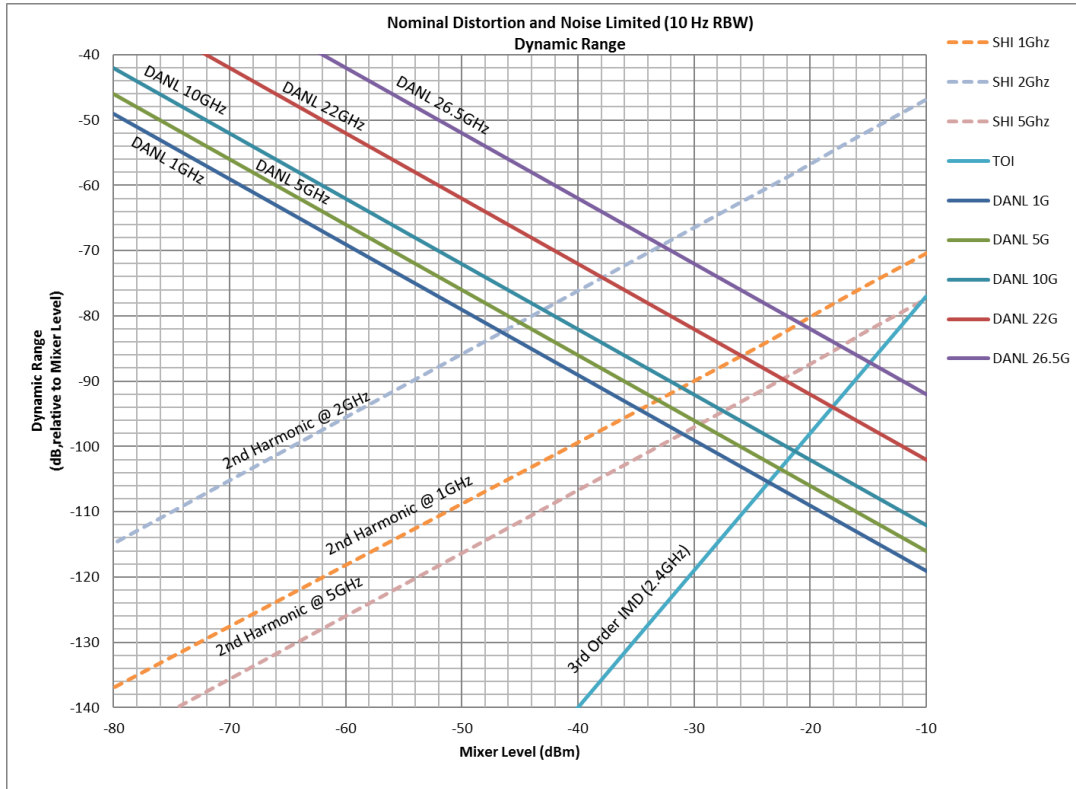

Applies to N995xA and N996xA

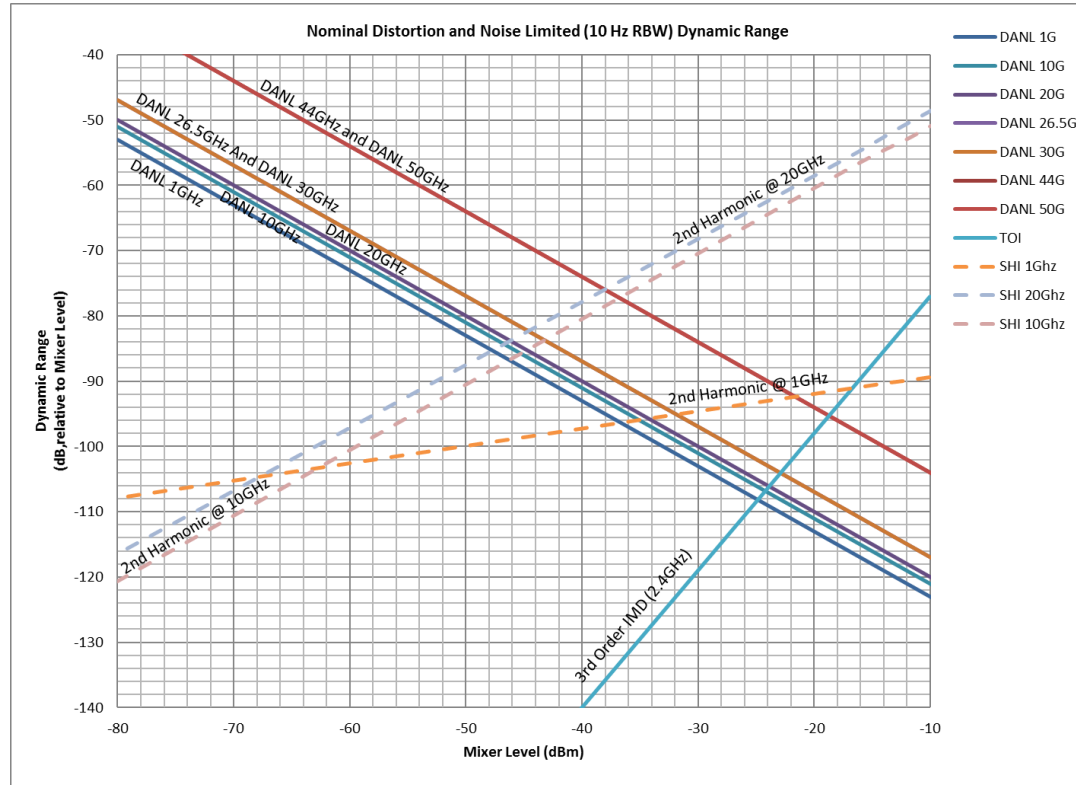



## Spectrum Analyzer (continued)

### SSB phase noise at 1 GHz center frequency

Phase noise (dBc/Hz) Offset	SSB phase noise at 1 GHz (N991xA, N993xA, N995xA, N996xA)			
	Spec (23 ± 5°C)	Spec (-10 to 55°C)	Typical (23 ± 5°C)	Typical (-10 to 55°C)
10 kHz	-106	-106	-111	-111
30 kHz	-106	-104	-110	-108
100 kHz	-100	-99	-105	-104
1 MHz	-110	-110	-113	-113
3 MHz	-119	-118	-122	-122
5 MHz	-120	-120	-123	-123

### Phase noise at different center frequencies (nominal)

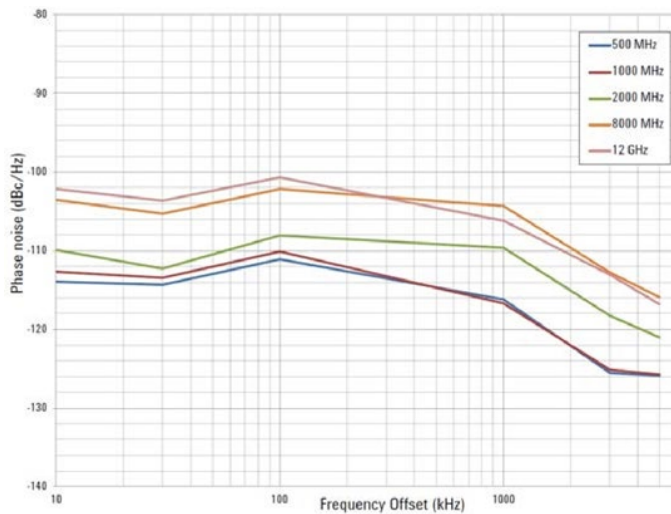

### Dynamic range versus offset frequency versus RBW (nominal)

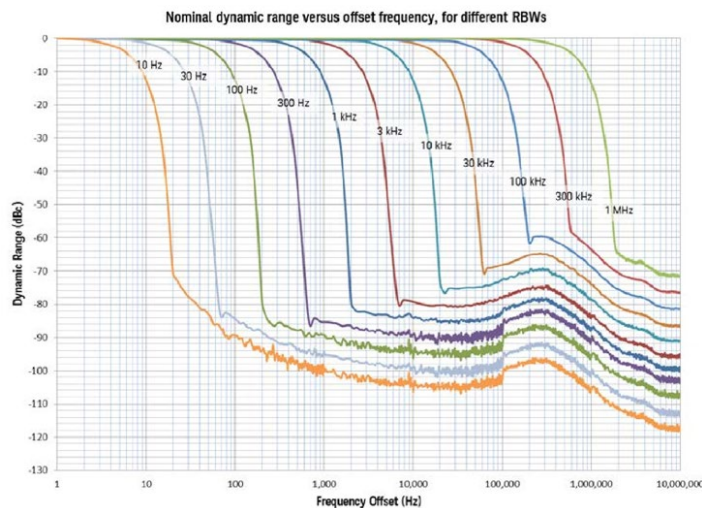

## Tracking Generator or Independent Source (See Configuration Guide for option information)

The performance listed in this section applies to the tracking generator and independent source capabilities available in the following models:

FieldFox RF & microwave (combination) analyzers:	N9913A, N9914A, N9915A, N9916A, N9917A, N9918A N9950A, N9951A, N9952A
FieldFox microwave spectrum analyzers:	N9935A, N9936A, N9937A, N9938A N9960A, N9961A, N9962A

See [FieldFox Configuration Guide](#) for option information. Many capabilities listed in this Data Sheet require options.

Note: Traditional tracking generators track the receiver frequency only. In FieldFox analyzers, the tracking generator frequency can be set to either track the receiver frequency, or act as an independent CW source.

	Models	Tracking generator or independent source frequency range
N991xA, N993xA	N9913A	30 kHz to 4 GHz
	N9914A	30 kHz to 6.5 GHz
	N9915A, N9935A	30 kHz to 9 GHz
	N9916A, N9936A	30 kHz to 14 GHz
	N9917A, N9937A	30 kHz to 18 GHz
	N9918A, N9938A	30 kHz to 26.5 GHz
N995xA, N996xA	N9950A, N9960A	300 kHz to 32 GHz
	N9951A, N9961A	300 kHz to 44 GHz
	N9952A, N9962A	300 kHz to 50 GHz
<b>Power step size</b>		
	Power settable in 1 dB steps across power range	
<b>Functions</b>		
Mode	Continuous wave (CW), CW coupled, tracking (swept frequency)	
Operations	Normalization, frequency offset, spectral reversal	

## Tracking Generator or Independent Source (continued)

Output power (dBm)	Frequency	Typical	Nominal
N991xA, N993xA	30 to 300 kHz	-11	—
	> 300 kHz to 2 MHz	-3	-2
	> 2 to 625 MHz	-2	-1
	> 625 MHz to 3 GHz	1	3
	> 3 to 6.5 GHz	-1	1
	> 6.5 to 9 GHz	-2	0
	> 9 to 14 GHz	-4	-2.5
	> 14 to 18 GHz	-6	-4.5
	> 18 to 23 GHz	-10	-8.5
	> 23 to 26.5 GHz	-12	-11
N995xA, N996xA	300 to 500 kHz	—	-9
	> 500 kHz to 2 MHz	-1	—
	> 2 MHz to 1 GHz	2	—
	> 1 to 6.5 GHz	2	—
	> 6.5 to 18 GHz	4	—
	> 18 to 26.5 GHz	2	—
	> 26.5 to 39 GHz	1	—
	> 39 to 44 GHz	-1	—
	> 44 to 46 GHz	-2	—
> 46 to 50 GHz	-4	—	
Dynamic range (dB)	Frequency	Typical (-10 to 55°C) Preamp off	Nominal Preamp on
N991xA, N993xA	2 MHz to 2 GHz	97	112
	> 2 to 7 GHz	93	108
	> 7 to 11 GHz	88	103
	> 11 to 16 GHz	79	95
	> 16 to 21 GHz	71	86
	> 21 to 23 GHz	55	70
	> 23 to 25 GHz	50	65
	> 25 to 26.5 GHz	45	60
N995xA, N996xA	500 kHz to 2 MHz	79	100
	> 2 MHz to 2.1 GHz	101	115
	> 2.1 to 2.8 GHz	99	112
	> 2.8 to 4.5 GHz	101	115
	> 4.5 to 10 GHz	99	105
	> 10 to 18 GHz	88	95
	> 18 to 37 GHz	85	90
	> 37 to 40 GHz	77	82
	> 40 to 43 GHz	65	80
> 43 to 50 GHz	73	76	

## Real-Time Spectrum Analyzer (RTSA) (Option 350)

The performance listed in this section applies to the real-time spectrum analyzer capabilities available in the following models:

FieldFox RF & microwave (combination) analyzers:	N9913A, N9914A, N9915A, N9916A, N9917A, N9918A N9950A, N9951A, N9952A
FieldFox microwave spectrum analyzers:	N9935A, N9936A, N9937A, N9938A N9960A, N9961A, N9962A

See [FieldFox Configuration Guide](#) for option information. Many capabilities listed in this Data Sheet require options.

	Models	Real-time analysis frequency range <sup>1</sup>	
N991xA, N993xA	N9913A	1 MHz to 4 GHz	Usable to 5 kHz
	N9914A	1 MHz to 6.5 GHz	Usable to 5 kHz
	N9915A, N9935A	1 MHz to 9 GHz	Usable to 5 kHz
	N9916A, N9936A	1 MHz to 14 GHz	Usable to 5 kHz
	N9917A, N9937A	1 MHz to 18 GHz	Usable to 5 kHz
	N9918A, N9938A	1 MHz to 26.5 GHz	Usable to 5 kHz
N995xA, N996xA	N9950A, N9960A	1 MHz to 32 GHz	Usable to 5 kHz
	N9951A, N9961A	1 MHz to 44 GHz	Usable to 5 kHz
	N9952A, N9962A	1 MHz to 50 GHz	Usable to 5 kHz

Real-time analysis		
Maximum real-time bandwidth	10 MHz	
Measurements	Density Spectrum, Spectrogram, Real-time Spectrum	
Resolution bandwidth	1 Hz to 500 kHz	Span dependent, $20 \leq \text{Span}/\text{RBW} \leq 280$ . Default is 35.7 kHz
Minimum signal duration with 100% probability of intercept (POI) at full amplitude accuracy	12.2 $\mu$ s	At 10 MHz span, 500 kHz RBW
Minimum detectable signal	22 ns	Minimum detectable pulse width is the shortest pulse width of a pulsed CW signal that will display a peak amplitude that is no worse than 60 dB below the peak amplitude of a CW signal of the same power level for a 10 MHz span and auto-coupled RBW
Spurious-free dynamic range across maximum BW	63 dB	
FFT rate	120,000 FFT/s	At 10 MHz span
IF flatness (typical)	$\pm 0.2$ dB $\leq 26.5$ GHz,	$\pm 0.3$ dB $> 26.5$ GHz
Number of display points	561	
Min. acquisition time	20 ms	At 10 MHz span
Max. acquisition time	500 ms	At 10 MHz span
Traces		
Number of traces	4: all four can be active simultaneously and in different states	
Detectors	Normal, positive peak, negative peak, sample, average (RMS)	
States	Clear/write, max. hold, min. hold, average, view, blank	

<sup>1</sup> Performance specified above 1 MHz. Usable down to 5 kHz.

## RTSA (continued)

Markers	
Number of markers	6
Type	Normal, delta, peak
Marker →	Peak, next peak, center frequency, reference level
Trigger	
Trigger type	Free run, external, video, RF burst, periodic

## I/Q Analyzer (IQA) (Option 351)

The specifications in this section apply to the I/Q analyzer capabilities available in the following models:

FieldFox RF & microwave (combination) analyzers:	N9913A, N9914A, N9915A, N9916A, N9917A, N9918A N9950A, N9951A, N9952A
FieldFox microwave spectrum analyzers:	N9935A, N9936A, N9937A, N9938A N9960A, N9961A, N9962A

See [FieldFox Configuration Guide](#) for option information. Many capabilities listed in this Data Sheet require options.

	Models	I/Q analysis frequency range <sup>1</sup>
N991x, N993x	N9913A	1 MHz to 4 GHz
	N9914A	1 MHz to 6.5 GHz
	N9915A, N9935A	1 MHz to 9 GHz
	N9916A, N9936A	1 MHz to 14 GHz
	N9917A, N9937A	1 MHz to 18 GHz
	N9918A, N9938A	1 MHz to 26.5 GHz
N995x, N996x	N9950A, N9960A	1 MHz to 32 GHz
	N9951A, N9961A	1 MHz to 44 GHz
	N9952A, N9962A	1 MHz to 50 GHz

Measurements	
Spectrum (frequency domain)	Magnitude spectrum
Waveform (time domain)	RF envelope
	I/Q waveform (Dual simultaneous top and bottom windows: I vs. time and Q vs. time)
Display (multi-domain)	
User Defined	User can set up and display up to 4 simultaneous and multi-domain measurements with any combination of the following: <ul style="list-style-type: none"> <li>Frequency domain: Magnitude spectrum</li> <li>Time domain: RF envelope, Q vs. I (polar plot), Phase vs. time, Unwrapped phase vs. time, I vs. time, Q vs. time</li> <li>Time summary table showing I/Q capture settings: I/Q capture time, waveform start/stop, Spectrum FFT time</li> </ul>
Measurement Setup	
I/Q capture parameters	Capture time, sample rate, sample period, capture samples

<sup>1</sup> Performance specified above 1 MHz. Usable down to 5 kHz.

## IQA (continued)

Frequency		
Frequency span		
Resolution bandwidth (spectrum measurement)		
Range		
Overall	200 mHz to 3 MHz	1, 1.5, 2, 3, 5, 7.5, 10 sequence; arbitrary RBW settable via front panel and SCPI
10 MHz span	90 Hz to 3 MHz	FFT window flat top (default)
FFT window shapes	Flat Top (multiple), Uniform, Triangular, Hanning, Hamming, Gaussian (multiple), Blackman, Blackman-Harris (multiple), Kaiser Bessel (multiple), Others	
Model	N9913 /14 /15 /16 /17 /18A N9935 /36 /37 /38A Typical <sup>1</sup>	N9950 /51 /52A N9960 /61 /62A Typical <sup>1</sup>
Maximum bandwidth	10 MHz	10 MHz
IF flatness	Magnitude	$\pm 0.2$ dB
	Phase deviation from linearity <sup>2</sup>	2.3° peak-to-peak, 1.6° rms
	Group delay flatness (peak-to-peak) <sup>39</sup>	11 ns
EVM (at center frequency 1 GHz)	LTE-A FDD TM3.1 (10 MHz)	0.8%
	WCDMA TM4 (5 MHz)	0.8%
EVM (at center frequency 2.1 GHz)	LTE-A FDD TM3.1 (10 MHz)	1%
	WCDMA TM4 (5 MHz)	1.1%
<b>Spur free dynamic range (dB) at 2.4 GHz 2/3 (TOI - DANL) in 1 Hz RBW</b>		<b>Nominal</b>
N991xA, N993xA		> 105
N995xA, N996xA		> 104
Data acquisition (standard 10 MHz IF path)		
Total capture memory	32 MB	
Length single I/Q capture	8 bytes/sample	
Maximum length I/Q capture	4 MSa	
Sample rate (I/Q pairs)	1.25 x span, Maximum 12.5 MHz	
Length (time units)	(Captured samples - 1)/Sample rate (I/Q pairs)	
ADC resolution	14 bits	
Maximum I/Q capture time		
10 MHz IFBW	320 ms	
1 MHz IFBW	3.2 s	
100 kHz IFBW	32 s	
10 kHz IFBW	320 s	
Traces		
Number of windows & layout	1, 2 (top & bottom), 3 (one top, two bottom), or 4 (quad display)	
Number of traces	4, all four traces can be active simultaneously in all windows	
States	Clear/write, max hold, min hold, average, view, blank	

<sup>1</sup> These numbers were generated from room temperature results (23° C).

<sup>2</sup> Not guaranteed below 50 MHz

## IQA (continued)

Markers	
Number of markers	6 normal + delta pairs
Type	Normal, delta, peak, marker table (up to 6 markers)
Couple markers	On/off (couple markers between traces in different windows)
Marker →	Peak, next peak, center frequency, reference level
Trigger	
Trigger type	Free run, external, video, RF burst
Trigger slope	Positive edge, negative edge
Trigger delay	Range: -150 ms to 500 ms Resolution: 100 ns
Auto trigger	Forces a periodic acquisition in the absence of a trigger event Range: 0 (off) to 30 s
Data Storage	
Data types	Trace, Trace+state, picture (PNG)
I/Q capture data file types	CSV, text (TXT), SDF (compatible with 89600 VSA software), Matlab (MAT)
I/Q data formats via SCPI	Raw binary interleaved I/Q data recording, REAL32 (ASCII is default)

## Noise Figure (NF) (Option 356)

The specifications in this section apply to the noise figure measurement capabilities available in the following models:

FieldFox RF & microwave (combination) analyzers:	N9913A, N9914A, N9915A, N9916A, N9917A, N9918A N9950A, N9951A, N9952A
FieldFox microwave spectrum analyzers:	N9935A, N9936A, N9937A, N9938A N9960A, N9961A, N9962A

See [FieldFox Configuration Guide](#) for option information. Many capabilities listed in this Data Sheet require options.

No warm-up is required for the instrument specifications.

	Models	Noise figure analysis frequency range
N991x, N993x	N9913A	10 MHz to 4 GHz
	N9914A	10 MHz to 6.5 GHz
	N9915A, N9935A	10 MHz to 9 GHz
	N9916A, N9936A	10 MHz to 14 GHz
	N9917A, N9937A	10 MHz to 18 GHz
	N9918A, N9938A	10 MHz to 26.5 GHz
N995x, N996x	N9950A, N9960A	10 MHz to 32 GHz
	N9951A, N9961A	10 MHz to 44 GHz
	N9952A, N9962A	10 MHz to 50 GHz

## NF (continued)

Measurements			
Noise figure	Noise figure (F dB)		
Noise factor	Noise figure as a ratio (F)		
Gain	Gain (G dB)		
Noise temperature	Noise temperature in Kelvin (K)		
Y-factor	Y-factor (Y dB)		
Setup parameters		Supplemental information	
Noise source	Load ENR value(s)		
DUT type	Amplifier, Downconverter, Upconverter, Multi-stage Converter		Built-in GUI wizard aids DUT measurement setup
Integration	Mode	Auto	Auto Integration: optimizes gain to avoid compression, and measurement time to achieve jitter goal
		Fixed	Fixed Integration: the time per point over which the measurement is averaged is fixed
	Jitter goal	Sets measurement jitter performance target	
	Max time / point	Allows user to trade-off jitter vs. measurement time	
	Jitter warning	On: displays circles on trace data if jitter goal is exceeded Off (default): disables trace circle indicators	
Loss compensation	Before DUT, After DUT		User definable, compensates measurement for loss (dB) before and after DUT
Measurement bandwidth (nominal)			
Range	5 MHz (default), 2 MHz, 1 MHz, 300 kHz		
Frequency reference			
Refer to spectrum analyzer specifications			
Noise figure uncertainty calculator			Supplemental information
			Built-in Based on data from measurement
DUT	Mode	Spot	Applies single values uniformly across frequency: Input $ \Gamma $ and Output $ \Gamma $ $\Gamma$ specification style: Maximum, 95th percentile, 80th percentile, Median, Mean, Fixed $\Gamma$ distribution: Rayleigh, Fixed, Uniform in Circle
		Table	Applies a table of values vs. frequency: Input $ \Gamma $ and Output $ \Gamma $ $\Gamma$ specification style: Maximum, 95th percentile, 80th percentile, Median, Mean, Fixed $\Gamma$ distribution: Rayleigh, Fixed, Uniform in Circle
Preamplifier	Mode	Spot	Applies single values uniformly across frequency Input $ \Gamma $ and Output $ \Gamma $ $\Gamma$ specification style: Maximum, 95th percentile, 80th percentile, Median, Mean, Fixed $\Gamma$ distribution: Rayleigh, Fixed, Uniform in Circle
		Table	Applies a table of values vs. frequency: Input $ \Gamma $ and Output $ \Gamma $ $\Gamma$ specification style: Maximum, 95th percentile, 80th percentile, Median, Mean, Fixed $\Gamma$ distribution: Rayleigh, Fixed, Uniform in Circle



## NF (continued)

Noise figure uncertainty calculator		Supplemental information
		Built-in Based on data from measurement
Noise source	ENR Mode	Spot Applies single values uniformly across frequency: ENR (dB), ENR Uncertainty (dB), On $ \Gamma $ , Off $ \Gamma $ , ENR Uncertainty Confidence (SD) $\Gamma$ specification style: Maximum, 95th percentile, 80th percentile, Median, Mean, Fixed $\Gamma$ distribution: Rayleigh, Fixed, Uniform in Circle
		Table Applies a table of values vs. frequency: ENR (dB), ENR Uncertainty (dB), On $ \Gamma $ , Off $ \Gamma $ , ENR Uncertainty Confidence (SD) $\Gamma$ specification style: Maximum, 95th percentile, 80th percentile, Median, Mean, Fixed $\Gamma$ distribution: Rayleigh, Fixed, Uniform in Circle
Uncertainty contributions	Jitter	Random independent events (fluctuations) within the bandwidth occurring during the noise measurement
	ENR	Excess noise ratio of the hot noise source connected to the DUT during the measurement
	Mismatch	Errors resulting from reflections due to impedance differences between components
	User calibration	Errors due to the optional user calibration which is performed with a defined noise standard (ENR source) connected to the input of an LNA, and fixturing/cables used in the DUT measurement, and port 2 of the FieldFox
Uncertainty coverage		User settable, uncertainty coverage can be set to $1\sigma$ (80%), $2\sigma$ (95% default), $3\sigma$ (99.5%)
Uncertainty bars		Displays vertical bars representing the calculated measurement uncertainty overlaid on the trace data
Loss compensation	Before DUT	User definable, single value, compensates measurement for insertion loss (dB) before DUT
	After DUT	User definable, single value, compensates measurement for loss (dB) after DUT
Instrument match		VSWR values are preloaded and automatically applied for instrument and U7227A/C/F or U7228A/C/F preamplifiers
<b>Calibration options</b>		
Receiver calibration		Uses noise source to calibrate FieldFox receiver gain bandwidth
User calibration with external U7227A/C/F or U7228A/C/F preamplifier		Optional calibration performs hot/cold measurement with external preamplifier; applies receiver and user calibrations

## NF (continued)

Noise figure <sup>1</sup>				
Model	Frequency	Internal preamplifier ON (dB)	Internal preamplifier ON + U7227/8A (dB)	Internal preamplifier ON + U7227/8C (dB)
N991xA, N993xA	10 to 100 MHz	22.5	9.0	—
	> 100 MHz to 4 GHz	22.5	8.2	9.2
	> 4 to 4.5 GHz	22.5	—	8.2
	> 4.5 to 6 GHz	26.5	—	10.6
	> 6 to 7 GHz	26.5	—	10.1
	> 7 to 13 GHz	28.5	—	11.4
	> 13 to 17 GHz	32.5	—	13.5
	> 17 to 18 GHz	34.5	—	14.4
	> 18 to 22 GHz	34.5	—	14.3
	> 22 to 25 GHz	42.5	—	20.8
	> 25 to 26.5 GHz	47.5	—	24.9
Model	Frequency	Internal preamplifier ON (dB)	Internal preamplifier ON + U7227/8C (dB)	Internal preamplifier ON + U7227/8F (dB)
N995xA, N996xA	10 to 100 MHz	18.5	—	—
	> 100 MHz to 2.1 GHz	18.5	7.6	—
	> 2.1 to 2.8 GHz	21.5	8.5	11.1
	> 2.8 to 4 GHz	20.5	8.0	9.3
	> 4 to 4.5 GHz	20.5	7.3	9.2
	> 4.5 to 6 GHz	22.5	8.1	9.7
	> 6 to 7 GHz	22.5	7.4	9.6
	> 7 to 13 GHz	26.5	9.9	11.2
	> 13 to 18 GHz	29.5	11.0	12.1
	> 18 to 22 GHz	29.5	10.2	11.5
	> 22 to 26.5 GHz	31.5	10.9	12.1
	> 26.5 to 35 GHz	31.5	—	11.5
	> 35 to 40 GHz	35.5	—	12.7
	> 40 to 44 GHz	41.5	—	16.6
	> 44 to 46 GHz	41.5	—	16.1
> 46 to 50 GHz	44.5	—	18.1	

<sup>1</sup> Noise figure (NF) = DANL - (-173.98 - 2.51) dB

Nominal calculation is based on spectrum analyzer (SA) displayed average noise level (DANL) specification (dBm) stated as input terminated, RMS detection, log averaging, 0 dB input attenuation, reference level of -20 dBm, normalized to 1 Hz RBW.

Noise figure (NF) = D - (K - L), where D is the DANL (displayed average noise level) specification, K is kTB (-173.98 dBm in a 1 Hz bandwidth at 290 K), and L is 2.51 dB (the effect of log averaging used in DANL verifications).

## NF (continued)

External preamplifier			
Specification	U7227/8A	U7227/8C	U7227/8F
Frequency	10 MHz to 4 GHz	100 MHz to 26.5 GHz	2 GHz to 50 GHz
Noise figure (dB)	10 MHz to 100 MHz: < 5.5 100 MHz to 4 GHz: < 5	100 MHz to 4 GHz: < 6 4 to 6 GHz: < 5 6 to 18 GHz: < 4 18 to 26.5 GHz: < 5	2 to 4 GHz: < 10 4 to 40 GHz: < 8 40 to 44 GHz: < 9 44 to 50 GHz: < 10
Gain (dB)	10 to 100 MHz: > 16 100 MHz to 4 GHz: > 0.5F + 17	100 MHz to 26.5 GHz: > 16.1 + 0.26F	2 GHz to 50 GHz: > 16.5 + 0.23F
RF connector	3.5 mm (m)	3.5 mm (m)	2.4 mm (m)
Noise source			
Model	Frequency range	ENR	
346A	10 MHz to 18 GHz	5 to 7 dB	
346B	10 MHz to 18 GHz	14 to 16 dB	
346C	10 MHz to 26.5 GHz	12 to 17 dB	
346CK40	1 GHz to 40 GHz	3 to 14 dB	
346CK01	1 GHz to 50 GHz	7 to 20 dB	
Noise source setup		Supplemental info	
ENR Mode	Spot	Single ENR value (not frequency dependent) (default: 15 dB)	
	Table	Applies table of ENR values vs. frequency Create, save, recall, edit ENR tables File type: .ENR	
T cold	Auto (default) or Manual	Noise temperature of cold noise standard connected to DUT during the measurement	
Noise source setup		Supplemental info	
Connector type	SMB (m)	DC bias requires accessory N9910X-713 BNC to SMB cable	
Control voltage drive level	28 ± 1 V		
Operating temperature	0 to 55°C		
Sweep			
Number of points	11 (default), 21, 51, 101, 201, 401, 601, 801, 1001		
Sweep mode	Continuous or single		
DUT profiles available (built-in GUI wizard aids DUT measurement setup)			
Amplifier	Includes any non-frequency-converting device		
Downconverter	Frequency context can be set to RF or IF; sideband can be set to LSB, USB, DSB		
Upconverter	Frequency context can be set to RF or IF; sideband can be set to LSB, USB, DSB		
Multi-stage converter	Frequency context can be set to RF or IF		

## NF (continued)

Display formats	
Number of traces	Two traces available
Display formats	Single-trace
	Dual-trace overlay (both traces on one graticule)
	Dual-trace split (each trace on separate top and bottom graticules)
Display data	Display data, memory, data and memory
Trace memory	One memory trace per data trace, total of 2 memory traces
Limit lines	Upper and lower for each trace
Markers	
Number of markers	6
Type	Normal, Delta, Marker Table
Marker table	Display 6 markers
Marker to →	Peak, Next Peak, Peak Left, Peak Right, Center Frequency, Reference Level, Minimum, Target
Data storage	
Data types	Trace, Trace+State, Picture (PNG), CSV

The performance listed in these sections below applies to the spectrum analyzer IF output, preamplifier, interference analyzer and spectrogram, channel scanner and 89600 VSA software capabilities available in the following models:

FieldFox RF & microwave (combination) analyzers: N9913A, N9914A, N9915A, N9916A, N9917A, N9918A  
N9950A, N9951A, N9952A

FieldFox microwave spectrum analyzers: N9935A, N9936A, N9937A, N9938A  
N9960A, N9961A, N9962A

See [FieldFox Configuration Guide](#) for option information. Many capabilities listed in this Data Sheet require options.

## Spectrum Analyzer IF Output

	Description
Center Frequency	33.75 MHz
IF bandwidth	5 MHz (default), 25 MHz
Connector	SMB male
Conversion loss (RF input to SA output with -10 dBm input power, 0 dB attenuation, and preamp off)	
N991xA, N993xA	0 to 27 dB nominal The loss increases approximately linearly as frequency increases, with ~27 dB loss at 26.5 GHz
N995xA, N996xA	0 to 27 dB nominal The loss increases approximately linearly as frequency increases, with ~27 dB loss at 50 GHz

## Preamplifier (Option 235)

	Nominal	
Frequency range	Full band (100 kHz to maximum frequency of instrument)	
Gain	N991xA, N993xA	+20 dB, 100 kHz to 26.5 GHz
	N995xA, N996xA	+20 dB, 100 kHz to 7.5 GHz +15 dB, > 7.5 to 50 GHz

## Interference Analyzer and Spectrogram (Option 236)

	Description
Spectrogram display	Overlay, full screen, top, or bottom with active trace
Waterfall angle	Moderate, steep, gradual, wide angle
Markers	Time, delta time
Trace playback and recording	<ul style="list-style-type: none"> <li>-Record all spectrum analyzer measurements</li> <li>-Playback recorded data using FieldFox</li> <li>-Frequency mask trigger allows recording to occur upon trigger</li> <li>-Store data internally or USB or SD card</li> </ul>

## Channel Scanner (Option 312)

	Description
Scan Mode	Range or custom list
Display Type	Bar chart vertical, bar chart horizontal, channel power, strip chart, chart overlay, scan & listen
Data logging mode	Time with geo tagging
Trace playback and recording	<ul style="list-style-type: none"> <li>-Record channel power measurement</li> <li>-Playback recorded data using FieldFox</li> <li>-Store data internally or USB or SD card in .csv or .kml format</li> <li>-Data in .kml format can be exported to Google Earth</li> </ul>

## 89600 VSA Software

Model		N9913 /14 /15 /16 /17 /18A	N9950 /51 /52A
		N9935 /36 /37 /38A Typical <sup>1</sup>	N9960 /61 /62A Typical <sup>1</sup>
Maximum analysis bandwidth <sup>2</sup>		10 MHz	10 MHz
IF flatness	Magnitude	± 0.2 dB	± 0.2 dB ≤ 26.5 GHz, ± 0.3 dB > 26.5 GHz
	Phase deviation from linearity <sup>3</sup>	2.3° peak-to-peak, 1.6° rms	2.6° peak-to-peak, 1.8° rms
	Group delay flatness (peak-to-peak) <sup>3</sup>		11 ns
EVM (at center frequency 1 GHz)	LTE-A FDD TM3.1 (10 MHz)	0.8%	0.7%
	WCDMA TM4 (5 MHz)	0.8%	0.85%
EVM (at center frequency 2.1 GHz)	LTE-A FDD TM3.1 (10 MHz)	1%	1%
	WCDMA TM4 (5 MHz)	1.1%	1.2%

<sup>1</sup> These numbers were generated from the room temperature results (23° C)

<sup>2</sup> Analysis bandwidth is the instantaneous bandwidth available around a center frequency over which the input signal can be digitized for further analysis or processing in the time, frequency, or modulation domain.

<sup>3</sup> Not guaranteed below 50 MHz

## Over-the-Air (OTA) LTE FDD (Option 370)

The performance listed in this section applies to the OTA analyzer capabilities available in the following models:

FieldFox RF & microwave (combination) analyzers:	N9913A, N9914A, N9915A, N9916A, N9917A, N9918A N9950A, N9951A, N9952A
FieldFox microwave spectrum analyzers:	N9935A, N9936A, N9937A, N9938A N9960A, N9961A, N9962A

See [FieldFox Configuration Guide](#) for option information. Many capabilities listed in this Data Sheet require options.

	Models	OTA analysis frequency range <sup>1</sup>
N991x, N993x	N9913A	1 MHz to 4 GHz
	N9914A	1 MHz to 6.5 GHz
	N9915A, N9935A	1 MHz to 9 GHz
	N9916A, N9936A	1 MHz to 14 GHz
	N9917A, N9937A	1 MHz to 18 GHz
	N9918A, N9938A	1 MHz to 26.5 GHz
N995x, N996x	N9950A, N9960A	1 MHz to 32 GHz
	N9951A, N9961A	1 MHz to 44 GHz
	N9952A, N9962A	1 MHz to 50 GHz

### Measurements<sup>2</sup>

LTE FDD Over-the-Air (OTA)	
Cell scan results	Center frequency PCI (Physical Cell Identifier) (C/S/G) RSRP (Reference Signal Received Power) (dBm) RSRQ (Reference Signal Received Quality) (dB) RSSI (Reference Signal Strength Indicator) (dBm) PSS (Primary Synchronization Signal) (dBm) SSS (Secondary Synchronization Signal) (dBm) SINR (Signal to Interference & Noise Ratio) (dB) Freq Err (Frequency Error) (Hz)
Data formats	User can setup and display 1, 2, 3 or 4 simultaneous measurements of key performance indicators (KPI's) for any component carrier (CC0 through CC4), up to 5 carriers, in any combination of the following:
Table	Cell scan numeric results (for up to 6 cell sites (ID's) including Cell ID (C/S/G), RSRP, RSRQ, RSSI, PSS, SSS, SINR, Freq Err
Bar chart	Vertical power bar graph of selectable cell scan results for up to 6 cell sites with adjustable color "heat" amplitude scale
Spectrum	Magnitude spectrum frequency domain (fixed span)
Strip chart	Magnitude of selectable cell scan results graphed over time
Signal bandwidth	Up to 10 MHz

<sup>1</sup> Performance specified above 1 MHz. Usable down to 5 kHz.

<sup>2</sup> For center frequency signals above 1 GHz, the built-in GPS receiver (Option 307) is highly recommended or locking to any 10 MHz frequency reference. When locked to GPS as the frequency reference, this provides accuracy of  $\pm 0.01$  ppm (spec).

## OTA LTE FDD (continued)

Setup parameters	
Component carrier	CC0 to CC4
Channel table	Sets frequency based on band and channel
Favorites list	Save up to 6 favorite cellular bands/channels
Window configuration	Any combination of 1, 2, 3, or all 4 windows can be displayed simultaneously; 1, 2 (top & bottom), 3 (one top, two bottom), or 4 (quad display)
Trigger	
Trigger type	Free run, external
Trigger slope	Positive edge, negative edge
Trigger delay	Range: -150 ms to 500 ms
Auto trigger	Forces a periodic acquisition in the absence of a trigger event Range: 0 (off) to 30 s
Record / Playback	
Data logging	Record, recall and playback data for all component carrier(s)
Record settings	Meas Interval, Interval type (time or distance), time interval, distance interval
Supported file types	CSV, KML
Saving data	Save/recall recorded data logs to/from internal memory or external USB stick or SD card

## Over-the-Air (OTA) 5GTF (Option 377)

The performance listed in this section applies to the OTA analyzer capabilities available in the following models:

FieldFox RF & microwave (combination) analyzers: N9913A, N9914A, N9915A, N9916A, N9917A, N9918A  
N9950A, N9951A, N9952A

FieldFox microwave spectrum analyzers: N9935A, N9936A, N9937A, N9938A  
N9960A, N9961A, N9962A

See [FieldFox Configuration Guide](#) for option information. Many capabilities listed in this Data Sheet require options.

	Models	OTA analysis frequency range <sup>1</sup>
N991x, N993x	N9913A	1 MHz to 4 GHz
	N9914A	1 MHz to 6.5 GHz
	N9915A, N9935A	1 MHz to 9 GHz
	N9916A, N9936A	1 MHz to 14 GHz
	N9917A, N9937A	1 MHz to 18 GHz
	N9918A, N9938A	1 MHz to 26.5 GHz
N995x, N996x	N9950A, N9960A	1 MHz to 32 GHz
	N9951A, N9961A	1 MHz to 44 GHz
	N9952A, N9962A	1 MHz to 50 GHz

<sup>1</sup> Performance specified above 1 MHz. Usable down to 5 kHz.

## OTA 5GTF (continued)

<b>Measurements<sup>1</sup></b>	
5GTF Over-the-Air (OTA)	
Cell scan results	Center frequency PCI (Physical Cell Identifier) Power (Channel Power) (dBm) PSS (Primary Synchronization Signal) (dBm) SSS (Secondary Synchronization Signal) (dBm) Sync Corr (Sync Correlation) (%)
Data formats	User can setup and display 1, 2, 3 or 4 simultaneous measurements of key performance indicators (KPI's) for any component carrier (CC0 through CC7), up to 8 carriers, in any combination of the following:
Table	Cell scan numeric results (for up to 6 cell sites (ID's) including Cell ID, Channel Power, PSS, SSS, Sync Corr
Bar chart	Vertical power bar graph of selectable cell scan results for up to 8 cell sites with adjustable color "heat" amplitude scale
Spectrum	Magnitude spectrum frequency domain (fixed span)
Strip chart	Magnitude of selectable cell scan results graphed over time
Signal bandwidth	Up to 10 MHz
<b>Setup parameters</b>	
Component carrier	CC0 to CC7
Channel table	Sets frequency based on band and channel
Window configuration	Any combination of 1, 2, 3, or all 4 windows can be displayed simultaneously; 1, 2 (top & bottom), 3 (one top, two bottom), or 4 (quad display)
<b>Trigger</b>	
Trigger type	Free run, external
Trigger slope	Positive edge, negative edge
Trigger delay	Range: -150 ms to 500 ms
Auto trigger	Forces a periodic acquisition in the absence of a trigger event Range: 0 (off) to 30 s
<b>Record / Playback</b>	
Data logging	Record, recall and playback data for all component carrier(s)
Record settings	Meas Interval, Interval type (time or distance), time interval, distance interval
Supported file types	CSV, KML
Saving data	Save/recall recorded data logs to/from internal memory or external USB stick or SD card

<sup>1</sup> For center frequency signals above 1 GHz, the built-in GPS receiver (Option 307) is highly recommended or locking to any 10 MHz frequency reference. When locked to GPS as the frequency reference, this provides accuracy of  $\pm 0.01$  ppm (spec).



## AM/FM Analog demodulation, Tune and Listen (Option 355)

The performance listed in this section applies to the AM/FM analog demodulation, tune and listen capabilities available in the following models:

FieldFox RF & microwave (combination) analyzers:	N9913A, N9914A, N9915A, N9916A, N9917A, N9918A N9950A, N9951A, N9952A
FieldFox microwave spectrum analyzers:	N9935A, N9936A, N9937A, N9938A N9960A, N9961A, N9962A

See [FieldFox Configuration Guide](#) for option information. Many capabilities listed in this Data Sheet require options.

	Description
Display type	RF spectrum view, demodulated waveform, including peak+ and peak- traces
Audio demodulation type	AM, FM narrow, FM wide, listen to the tones using FieldFox's built-in speaker or headphones
Audio bandwidth	16 kHz
Measurement type	RF carrier power (dBm), RF carrier frequency (Hz), modulation rate (Hz), SINAD (dB), THD (%)
<b>Receiver IF bandwidth</b>	<b>Nominal</b>
AM	35 kHz
FM narrow	12 kHz
FM wide	150 kHz
Listen time range	0 to 100 seconds
<b>AM &amp; FM metrics</b>	<b>Nominal</b>
SINAD	2.5 dB to 65 dB
THD	0 to 75%
<b>AM measurements</b>	<b>Nominal</b>
Maximum modulation rate	5 kHz, demod sweep time: 50 $\mu$ s to 50 ms
Depth	(peak-to-peak/2) (%), $\pm$ peak depth (%)
Depth accuracy	$\pm$ 2%
Depth range	Modulation: 0.1 % to 99%
<b>FM measurements</b>	<b>Nominal</b>
Maximum modulation rate	5 kHz, demod sweep time: 50 $\mu$ s to 50 ms
Frequency deviation	(Hz), $\pm$ peak deviation (Hz)
Maximum deviation	30 kHz (typical)

### Radio standards

With a radio standard applied, pre-defined frequency bands, channel numbers or uplink / downlink selections can be used instead of manual frequency entry. The pre-defined FieldFox radio standards include bands such as W-CDMA, LTE, and GSM. Alternately, users can create custom standards and import them into FieldFox analyzers.

## Spectrum Analyzer Time Gating (Option 238)

The performance listed in this section applies to the spectrum analyzer time gating capabilities available in the following models:

FieldFox RF & microwave (combination) analyzers:	N9913A, N9914A, N9915A, N9916A, N9917A, N9918A N9950A, N9951A, N9952A
FieldFox microwave spectrum analyzers:	N9935A, N9936A, N9937A, N9938A N9960A, N9961A, N9962A

See [FieldFox Configuration Guide](#) for option information. Many capabilities listed in this Data Sheet require options.

With time gating, you can measure the spectrum of a periodic signal during a specified time interval. Pulsed-RF signals are an example of a periodic signal that can be measured with time gating. For example, you can measure the pulse during the on period, not the transition or the off period. Or you can exclude interfering signals such as a periodic transient. Time gating allows you to view spectral components that would otherwise be hidden. FieldFox's time gating method is a Gated FFT.

	Description
Gate method	Gated FFT
Span range	Any span
RBW range	1 Hz to 300 kHz (derived from gate width)
Gate delay range	-150 ms to 10 s
Gate width (length) range	6 $\mu$ s to 1.8 s
Gate sources	External, RF burst, Video

## Reflection Measurements (RL, VSWR) (Option 320, applicable to SA only models)

The performance listed in this section applies to the reflection measurements capabilities available in the following models:

FieldFox microwave spectrum analyzers:	N9935A, N9936A, N9937A, N9938A <sup>1</sup> N9960A, N9961A, N9962A
--	---

See [FieldFox Configuration Guide](#) for option information. Many capabilities listed in this Data Sheet require options.

	Models	Reflection Measurements
N993xA	N9935A	30 kHz to 9 GHz
	N9936A	30 kHz to 14 GHz
	N9937A	30 kHz to 18 GHz
	N9938A <sup>1</sup>	30 kHz to 26.5 GHz
N996xA	N9960A	300 kHz to 32 GHz
	N9961A	300 kHz to 44 GHz
	N9962A	300 kHz to 50 GHz

### Measurements

Return loss, VSWR normalization using data/memory

<sup>1</sup> Reflection measurements in N9938A specifically require 3.5 mm (m) test ports instead of the standard Type-N (f).

## Extended Range Transmission Analysis (ERTA) (Option 209)

ERTA specifications apply to the following FieldFox models. The RF & microwave analyzers must be equipped with the spectrum analyzer option.

FieldFox RF & microwave (combination) analyzers: N9913A, N9914A, N9915A, N9916A, N9917A, N9918A  
N9950A, N9951A, N9952A

FieldFox microwave spectrum analyzers: N9935A, N9936A, N9937A, N9938A  
N9960A, N9961A, N9962A

ERTA operation requires two FieldFox units, each one configured with specific options, and certain accessories. See [FieldFox Configuration Guide](#) for option information. Many capabilities listed in this Data Sheet require options.

### System description

ERTA can be used to measure the scalar transmission gain or loss of an RF system. It is useful when measuring long lossy cables where the two ends cannot easily be brought together, such as those bolted in on ships or aircrafts. It is also useful in measuring the insertion loss of waveguide systems, or using the frequency-offset feature, devices such as mixers and converters.

ERTA measurements are based on two FieldFox units; one at each end of the measured DUT. One FieldFox is the source and reference receiver (R), while the other is the measurement receiver (B). The two FieldFox units are synchronized using hardware triggering. By taking advantage of FieldFox's InstAlign technique, ERTA can be used to make accurate gain or loss measurements.

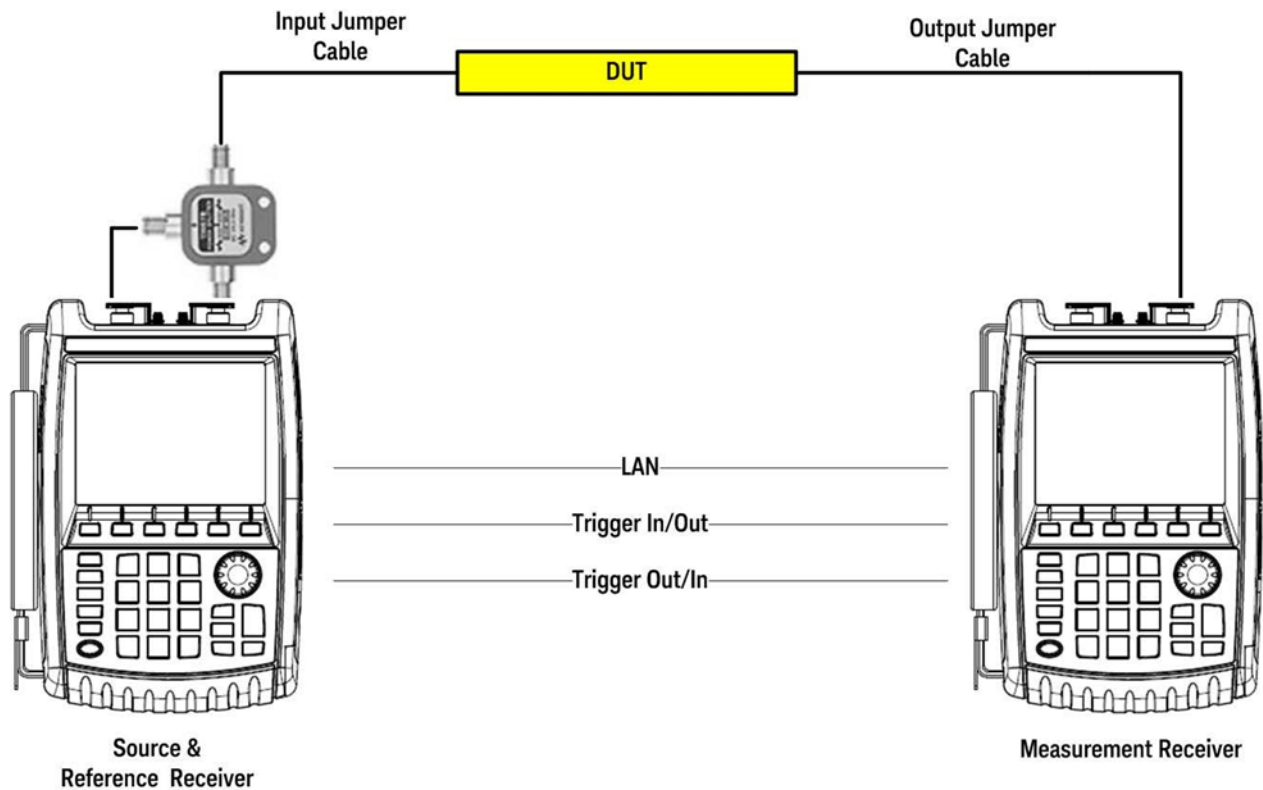

## ERTA (continued)

### Frequency specifications

The ERTA frequency range is limited by each individual analyzer's frequency range.

	Models	Reflection measurements	Receiver frequency range <sup>1</sup>
N991xA, N993xA	N9913A	30 kHz to 4 GHz	100 kHz to 4 GHz
	N9914A	30 kHz to 6.5 GHz	100 kHz to 6.5 GHz
	N9915A, N9935A	30 kHz to 9 GHz	100 kHz to 9 GHz
	N9916A, N9936A	30 kHz to 14 GHz	100 kHz to 14 GHz
	N9917A, N9937A	30 kHz to 18 GHz	100 kHz to 18 GHz
	N9918A, N9938A	30 kHz to 26.5 GHz	100 kHz to 26.5 GHz
N995xA, N996xA	N9950A, N9960A	300 kHz to 32 GHz	300 kHz to 32 GHz
	N9951A, N9961A	300 kHz to 44 GHz	300 kHz to 44 GHz
	N9952A, N9962A	300 kHz to 50 GHz	300 kHz to 50 GHz

#### Frequency reference

Refer to the frequency accuracy specifications.

#### Source output power

Refer to the test port output power typical data.

#### Frequency setup parameters

Receiver frequency	Center/span or start/stop (standard spectrum analyzer settings) Reverse receiver sweep direction (default direction is forward, but can be set to reverse)
Source frequency [Remote]	[Tracking] – FieldFox source tracks the receiver by default. The frequencies are identical. [CW] – FieldFox's source can be set to a CW frequency independent of FieldFox's receiver frequency. FieldFox's source is at a single CW frequency; FieldFox's receiver is swept. [Coupled CW] – FieldFox's source CW frequency is auto-coupled to FieldFox's receiver [Center Frequency] setting.

#### Frequency-offset capability

This feature allows the FieldFox's source frequency to be offset from FieldFox's receiver frequency. The offset frequency can be negative, zero, or positive. The frequency-offset capability is useful when characterizing the scalar transmission response of devices such as mixers and converters.

<sup>1</sup> The receiver (spectrum analyzer) is usable to 5 kHz, though only specified to 100 kHz or 300 kHz.

## ERTA (continued)

### Frequency specifications (continued)

Frequency-offset setup parameters	
Receiver frequency	Center/span or start/stop (standard spectrum analyzer settings) Reverse receiver sweep direction (default direction is forward, but can be set to reverse)
Frequency tracking offset	On/Off Offset values: 0, > 0, < 0
Receiver sweep direction	Reversal: Off Default setting Both source and receiver sweep in the forward direction. Receiver stop frequency > Receiver start frequency Source frequency = Offset + Receiver frequency  Reversal: On Source and receiver sweep in opposite directions. Source frequency = Offset – Receiver frequency Offset > receiver frequency

### Dynamic range and maximum attenuation

**Dynamic range** is the difference between the maximum output power available from FieldFox's source and the noise floor of the second FieldFox, while ensuring that neither FieldFox's ADC goes into over-range. Dynamic range also accounts for the loss of the power splitter. Dynamic range is applicable when testing devices such as filters, where there is low loss in the passband, and significant loss in the stopband, and both passband and stopband need to be on the display at the same time (same sweep).

**Maximum attenuation** is the difference between maximum output power available from FieldFox's source and the noise floor of FieldFox. It also accounts for the loss of power splitter. Maximum attenuation is applicable when testing devices such as cables, which have relatively uniform loss over the swept frequency range.

The values shown are based on the recommended minimum RBW of 3 kHz when the frequency references are locked via GPS, and 300 kHz when the frequency references are unlocked. Locking the frequency references to GPS allows for greater frequency accuracy of the FieldFox units and use of a narrower RBW, which in turn results in a lower DANL, and hence a wider measurement range. When the GPS signals cannot be present at all times, the GPS hold-over mode can be used.

## ERTA (continued)

### Dynamic range and maximum attenuation (continued)

Dynamic range (dB)		Typical			
N991xA, N993xA	Preamp off	Preamp on	Preamp off	Preamp on	
	Frequency references locked to GPS, RBW 3 kHz	Frequency references locked to GPS, RBW 3 kHz	Frequency references unlocked, RBW 300 kHz	Frequency references unlocked, RBW 300 kHz	
> 2 MHz <sup>1</sup> to 6 GHz	88	83	68	63	
> 6 to 13 GHz	86	83	66	63	
> 13 to 22 GHz	70	86	50	66	
> 22 to 25 GHz	63	83	43	63	
> 25 to 26.5 GHz	58	77	38	57	

Maximum attenuation (dB)		Typical			
N991xA, N993xA	Preamp off	Preamp on	Preamp off	Preamp on	
	Frequency references locked to GPS, RBW 3 kHz	Frequency references locked to GPS, RBW 3 kHz	Frequency references unlocked, RBW 300 kHz	Frequency references unlocked, RBW 300 kHz	
> 2 MHz to 6 GHz	93	108	73	88	
> 6 to 13 GHz	86	103	66	83	
> 13 to 22 GHz	70	91	50	71	
> 22 to 25 GHz	63	83	43	63	
> 25 to 26.5 GHz	58	77	38	57	

Dynamic range (dB)		Typical			
N995xA, N996xA	Preamp off	Preamp on	Preamp off	Preamp on	
	Frequency references locked to GPS, RBW 3 kHz	Frequency references locked to GPS, RBW 3 kHz	Frequency references unlocked, RBW 300 kHz	Frequency references unlocked, RBW 300 kHz	
> 2 to 5 MHz	83	87	62	58	
> 5 MHz to 11 GHz	93	97	69	68	
> 11 to 19 GHz	95	96	71	70	
> 19 to 22 GHz	93	94	69	68	
> 22 to 40 GHz	88	90	63	65	
> 40 to 43 GHz	82	89	57	64	
> 43 to 46 GHz	81	93	56	68	
> 46 to 50 GHz	77	88	52	63	

Maximum attenuation (dB)		Typical			
N995xA, N996xA	Preamp off	Preamp on	Preamp off	Preamp on	
	Frequency references locked to GPS, RBW 3 kHz	Frequency references locked to GPS, RBW 3 kHz	Frequency references unlocked, RBW 300 kHz	Frequency references unlocked, RBW 300 kHz	
> 2 MHz to 13 GHz	100	113	74	88	
> 13 to 18 GHz	101	110	76	85	
> 18 to 22 GHz	99	108	74	83	
> 22 to 35 GHz	95	105	70	80	
> 35 to 40 GHz	88	100	63	75	
> 40 to 46 GHz	81	93	56	63	
> 46 to 50 GHz	77	88	52	63	

<sup>1</sup> Dynamic range is decreased from 3 to 9 dB at 2 MHz.

## Absolute power and gain measurement uncertainties

Verified with input level of -10 dBm, peak detector, 10 dB attenuation, preamplifier off, all settings auto-coupled, no warm-up required. Includes frequency response uncertainties. Assumes an ERTA system using a Keysight 11667A, 11667B, or 11667C power splitter.

<b>N991xA and N993xA</b>				
<b>Input power (R) measurements uncertainty, 30 kHz RBW (dB)</b>				
	<b>Spec (23 ± 5°C)</b>	<b>Spec (-10 to 55°C)</b>	<b>Typical (23 ± 5°C)</b>	<b>Typical (-10 to 55°C)</b>
100 kHz to 18 GHz	± 1.10	± 1.30	± 0.40	± 0.50
> 18 to 26.5 GHz	± 1.40	± 1.50	± 0.50	± 0.60
<b>Output power (B) measurement uncertainty, frequency references locked to GPS, RBW ≥ 3 kHz (dB)</b>				
	<b>Spec (23 ± 5°C)</b>	<b>Spec (-10 to 55°C)</b>	<b>Typical (23 ± 5°C)</b>	<b>Typical (-10 to 55°C)</b>
100 kHz to 18 GHz	± 1.00	± 1.20	± 0.40	± 0.50
> 18 to 26.5 GHz	± 1.20	± 1.40	± 0.50	± 0.60
<b>Output power (B) measurement uncertainty, frequency references unlocked, RBW ≥ 300 kHz (dB)</b>				
	<b>Spec (23 ± 5°C)</b>	<b>Spec (-10 to 55°C)</b>	<b>Typical (23 ± 5°C)</b>	<b>Typical (-10 to 55°C)</b>
100 kHz to 18 GHz	± 1.00	± 1.30	± 0.40	± 0.50
> 18 to 26.5 GHz	± 1.40	± 1.60	± 0.50	± 0.60
<b>Gain/Loss (B/R) measurement uncertainty, frequency references locked to GPS, RBW ≥ 3 (dB)</b>				
	<b>Spec (23 ± 5°C)</b>	<b>Spec (-10 to 55°C)</b>	<b>Typical (23 ± 5°C)</b>	<b>Typical (-10 to 55°C)</b>
100 kHz to 18 GHz	± 1.30	± 1.70	± 0.60	± 0.70
> 18 to 26.5 GHz	± 1.70	± 2.10	± 0.70	± 0.90
<b>Gain/Loss (B/R) measurement uncertainty, frequency references unlocked, RBW ≥ 300 kHz (dB)</b>				
	<b>Spec (23 ± 5°C)</b>	<b>Spec (-10 to 55°C)</b>	<b>Typical (23 ± 5°C)</b>	<b>Typical (-10 to 55°C)</b>
100 kHz to 18 GHz	± 1.40	± 1.70	± 0.70	± 0.70
> 18 to 26.5 GHz	± 2.00	± 2.10	± 0.90	± 1.00
<b>N995xA and N996xA</b>				
<b>Input power (R) measurements uncertainty, 30 kHz RBW (dB)</b>				
	<b>Spec (23 ± 5°C)</b>	<b>Spec (-10 to 55°C)</b>	<b>Typical (23 ± 5°C)</b>	<b>Typical (-10 to 55°C)</b>
2 MHz to 18 GHz	± 1.10	± 1.30	± 0.50	± 0.60
> 18 to 32 GHz	± 1.20	± 1.50	± 0.50	± 0.70
> 32 to 40 GHz	± 1.30	± 1.80	± 0.60	± 0.80
> 40 to 43 GHz	± 1.60	± 2.30	± 0.70	± 1.10
> 43 to 50 GHz	± 1.70	± 3.20	± 0.80	± 1.40

## Absolute power and gain measurement uncertainties (continued)

Output power (B) measurement uncertainty, frequency references locked to GPS, RBW ≥ 3 kHz (dB)				
	Spec (23 ± 5°C)	Spec (-10 to 55°C)	Typical (23 ± 5°C)	Typical (-10 to 55°C)
2 MHz to 18 GHz	± 0.40	± 1.00	± 0.40	± 0.50
> 18 to 32 GHz	± 0.45	± 1.30	± 0.40	± 0.60
> 32 to 40 GHz	± 0.50	± 1.50	± 0.50	± 0.70
> 40 to 43 GHz	± 0.80	± 2.30	± 0.70	± 1.00
> 43 to 50 GHz	± 0.90	± 3.00	± 0.80	± 1.40
Output power (B) measurement uncertainty, frequency references unlocked, RBW ≥ 300 kHz (dB)				
	Spec (23 ± 5°C)	Spec (-10 to 55°C)	Typical (23 ± 5°C)	Typical (-10 to 55°C)
2 MHz to 18 GHz	± 1.00	± 1.10	± 0.40	± 0.50
> 18 to 32 GHz	± 1.20	± 1.50	± 0.50	± 0.60
> 32 to 40 GHz	± 1.60	± 1.90	± 0.60	± 0.80
> 40 to 43 GHz	± 2.10	± 2.50	± 0.70	± 1.30
> 43 to 50 GHz	± 2.60	± 3.60	± 1.00	± 1.60
Gain/Loss (B/R) measurement uncertainty, frequency references locked to GPS, RBW ≥ 3 (dB)				
	Spec (23 ± 5°C)	Spec (-10 to 55°C)	Typical (23 ± 5°C)	Typical (-10 to 55°C)
2 MHz to 18 GHz	± 1.40	± 1.70	± 0.60	± 0.70
> 18 to 32 GHz	± 1.50	± 2.00	± 0.70	± 0.90
> 32 to 40 GHz	± 1.60	± 2.30	± 0.80	± 1.00
> 40 to 43 GHz	± 2.20	± 3.10	± 1.00	± 1.40
> 43 to 50 GHz	± 2.40	± 4.00	± 1.20	± 1.90
Gain/Loss (B/R) measurement uncertainty, frequency references unlocked, RBW ≥ 300 kHz (dB)				
	Spec (23 ± 5°C)	Spec (-10 to 55°C)	Typical (23 ± 5°C)	Typical (-10 to 55°C)
2 MHz to 18 GHz	± 1.40	± 1.70	± 0.70	± 0.70
> 18 to 32 GHz	± 1.80	± 2.10	± 0.80	± 1.00
> 32 to 40 GHz	± 2.10	± 2.80	± 1.00	± 1.30
> 40 to 43 GHz	± 2.70	± 3.50	± 1.40	± 1.70
> 43 to 50 GHz	± 3.00	± 4.80	± 1.60	± 2.40

## Cable correction

Input and output jumper cable losses can be accounted for using ERTA's cable correction wizard.



The performance listed in built-in power meter, external USB power sensor support, pulse measurements, USB power sensor measurements versus frequency, built-in GPS receiver, DC bias variable voltage source and remote control capability sections applies to the capabilities available in the following models:

FieldFox RF & microwave (combination) analyzers: N9913A, N9914A, N9915A, N9916A, N9917A, N9918A  
N9950A, N9951A, N9952A

FieldFox microwave spectrum analyzers: N9935A, N9936A, N9937A, N9938A  
N9960A, N9961A, N9962A

See [FieldFox Configuration Guide](#) for option information. Many capabilities listed in this Data Sheet require options.

## Built-in Power Meter (Option 310)

Using the built-in power meter, FieldFox is able to make very accurate channel power measurements. The channel bandwidth can be set wide to simulate average power meter measurements. This measurement function provides the flexibility to make user definable channel power measurements.

Description			
Setup parameters	Center frequency, including selection of radio standards and channel selection, span or channel width		
Functions	Relative/absolute measurements, offsets, units of dBm or Watts, or dB or %, minimum and maximum limits		
Models	Frequency range		
N991xA, N992xA, N993xA	N9913A	100 kHz to 4 GHz	Usable to 5 kHz
	N9914A	100 kHz to 6.5 GHz	Usable to 5 kHz
	N9915A, N9925A, N9935A	100 kHz to 9 GHz	Usable to 5 kHz
	N9916A, N9926A, N9936A	100 kHz to 14 GHz	Usable to 5 kHz
	N9917A, N9927A, N9937A	100 kHz to 18 GHz	Usable to 5 kHz
	N9918A, N9928A, N9938A	100 kHz to 26.5 GHz	Usable to 5 kHz
N995xA, N996xA	N9950A, N9960A	9 kHz to 32 GHz	Usable to 5 kHz
	N9951A, N9961A	9 kHz to 44 GHz	Usable to 5 kHz
	N9952A, N9962A	9 kHz to 50 GHz	Usable to 5 kHz

Amplitude accuracy (dB)				
N991xA, N992xA, N993xA	Spec (23 ± 5°C)	Spec (-10 to 55°C)	Typical (23 ± 5°C)	Typical (-10 to 55°C)
10 dB attenuation, input signal -15 to -5 dBm, peak detector, preamplifier off, 300 Hz RBW, all settings auto-coupled, includes frequency response uncertainties. No warm-up required.				
100 kHz to 18 GHz	± 0.80	± 1.00	± 0.35	± 0.50
> 18 to 26.5 GHz	± 1.00	± 1.20	± 0.50	± 0.60
N995xA, N996xA	Spec (23 ± 5°C)	Spec (-10 to 55°C)	Typical (23 ± 5°C)	Typical (-10 to 55°C)
9 to 100 kHz	± 1.60	± 2.50	± 0.60	± 1.30
> 100 kHz to 2 MHz	± 1.30	± 1.90	± 0.60	± 0.80
> 2 to 15 MHz	± 1.00	± 1.20	± 0.30	± 0.50
> 15 MHz to 32 GHz	± 0.80	± 1.00 <sup>1</sup>	± 0.30	± 0.50
> 32 to 40 GHz	± 0.90	± 1.40	± 0.50	± 0.70
> 40 to 43 GHz	± 1.30	± 2.00	± 0.50	± 0.70
> 43 to 50 GHz	± 1.40	± 2.70	± 0.50	± 0.90

<sup>1</sup> Increase by 0.2 dB between 18 and 32 GHz.

## External USB Power Sensor Support (Option 302)

The external USB power sensor option supports various Keysight USB power sensors. For an up-to-date listing of the supported power sensors, visit <http://www.keysight.com/find/fieldfoxsupport>.

	Description
Setup parameters	Frequency
Functions	Relative/absolute measurements, offsets, units of dBm or Watts, or dB or %, minimum and maximum limits.
Internal source	FieldFox's internal source can be turned on in the USB power sensor mode. CW frequency and nominal power level control are available.

## Pulse Measurements (Option 330)

FieldFox's pulse measurement option can be used to characterize RF pulses such as those used in radar and electronic warfare systems. Measurements are made using FieldFox and Keysight's USB peak power sensors.

Performance specifications such as frequency, dynamic range and minimum pulse width depend on the peak power sensor. Supported peak power sensors: <http://www.keysight.com/find/fieldfoxsupport>

	Description
Setup parameters	Frequency, time (center), time/division, gating, triggering, video bandwidth, averaging
Functions	Average power, peak power, and peak to average ratio
	Analog gauge display and digital display, dBm and Watts
	Relative/absolute measurements, offset, dB or %, minimum and maximum limits
	Trace graph for pulse profiling with gating
	Rise time, fall time, pulse width, pulse period, pulse repetition frequency

## USB Power Sensor Measurements versus Frequency (Option 208)

This feature allows FieldFox's source frequency to be set independently from the power sensor (receiver) frequency. With frequency-offset using power sensor (FOPS), the frequency of both the source and receiver are swept, and the two track each other. The offset frequency can be negative, zero, or positive.

FOPS can be used to characterize the scalar transmission response of devices such as mixers and converters. This frequency-offset capability is necessary for conversion loss/gain measurements on frequency-translating devices, since by definition, the input and output frequencies of the DUT are different. The FieldFox source stimulates the DUT and the power sensor is used as the measurement receiver.

Since power sensors are inherently broadband devices (not frequency-selective), the user should ensure that only the signal of interest is present at the power sensor input and that all other signals are filtered appropriately.

## USB Power Sensor Measurements versus Frequency (continued)

Setup parameters	
Source frequency	Center/span or start/stop
Receiver frequency	Range determined by power sensor range
Frequency offset	Positive offset or negative offset
Frequency step size	30 kHz minimum
Number of points	2 to 1601
Combination of number of points and frequency step size limited by span.	
Dwell time/point	0 to 1.0 sec

Source frequency span must be equal to receiver frequency span.

Receiver sweep direction: forward (default setting) or reverse.

For some DUTs, the output frequency may sweep in a reverse direction, as compared to the source frequency. The basic relationships between the source, receiver and offset frequencies are shown in the table below. The FieldFox analyzer includes an offset calculator that ensures a fast measurement setup.

Src sweep direction	Rx sweep direction	Frequency calculations
Forward $f_{2src} > f_{1src}$	Forward $f_{2rx} > f_{1rx}$	Receiver frequency = Source frequency $\pm$ Offset
Forward $f_{2src} > f_{1src}$	Reverse $f_{2rx} > f_{1rx}$	Receiver frequency = Offset - Source Frequency Offset > Source frequency

	Description
Measurements	Source power, gain/loss and receiver (Rx) power Gain = Rx power / source power (memory). Source power (memory) is measured during setup.
Output power	Refer to the test port output power typical data on page 5.
Dynamic range	The dynamic range with FOPS is dependent on FieldFox's output power and the power sensor's dynamic range. Supported USB power sensors: <a href="http://www.keysight.com/find/fieldfoxsupport">www.keysight.com/find/fieldfoxsupport</a>

The graph below shows a filter measurement using two different power sensors, the U2002A (-60 to +20 dBm) and the U2021XA (-45 to +20 dBm). While a filter is not commonly measured using FOPS, it is a useful device for demonstrating dynamic range.

For both measurements, the FieldFox source power was set to -1 dBm, the maximum available in the selected frequency range of 7.25 to 13.25 GHz. An external amplifier was not used in this case, but one can be added to increase the source power and hence dynamic range.

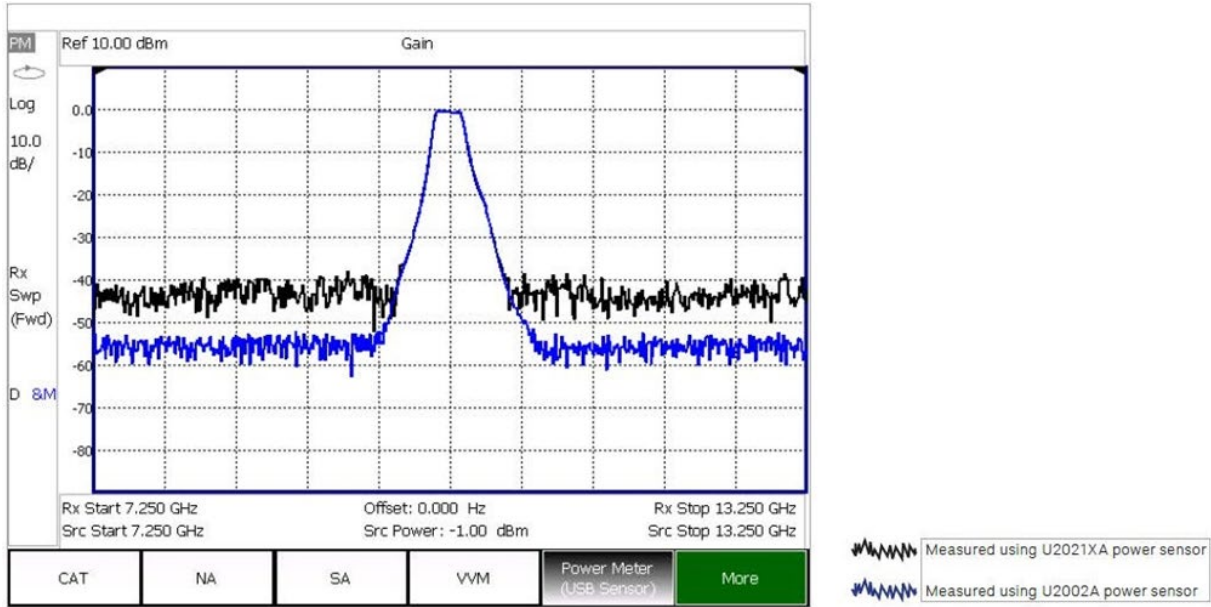

Example showing typical dynamic range of FOPS

## Built-In GPS Receiver (Option 307)

	Description
GPS receiver	The internal GPS receiver can be used as a frequency reference. <sup>1</sup>
Modes	Off, internal, external
Sync clock	On, off
Functionality	Geo-location: latitude, longitude, altitude (elevation), time, sync time/date Requires external GPS antenna (can use N9910X-825, GPS active antenna)
Connector for antenna	SMA (f), 3.3 V
Maximum DC current	13 mA

## DC Bias Variable-Voltage Source (Option 309)

	Description
	Nominal
Connector	SMB (m)
Voltage	+1 to +32 V
Resolution	0.1 V
Maximum current <sup>2</sup>	0.65 A
DC current readout resolution	0.01 A
Maximum power <sup>2</sup>	7 watts
Display read out	Voltage, current
Overload trip protection	Automatically engages when voltage source is on. The trip circuit can be reset from front panel without presetting or power cycling the analyzer.

<sup>1</sup> External GPS USB receivers can be used to provide geo-location data. However, they cannot be used for frequency reference locking.

<sup>2</sup> Battery life will be reduced when DC source is used. A trip function turns off the power supply when the rated current or power is exceeded.

## Remote Control Capability (Option 030)

Option 030 adds remote control capability to FieldFox analyzers, so that FieldFox can be controlled via an iOS device. The FieldFox app, running on the iOS device, combined with Option 030 on the FieldFox analyzer provides full control of the instrument from a remote location. The app emulates the front panel of FieldFox, so users can press the FieldFox hardkeys or softkeys using their iPhone or iPad and make measurements remotely.

For example, a tower climber can be on the tower with a FieldFox analyzer, while the technician controls and makes the measurements down below, using an iPad. The iPad and FieldFox communicate via a network connection.

iOS device requirements

- iPad, iPhone, or iPod Touch
- iOS of 6.1 or higher
- A WiFi or 3G/4G connection

The FieldFox app communicates with FieldFox via a network connection, so both the iOS device and FieldFox need to be on a network where both devices can reach the other. For example, a company intranet or a site installation using a wireless router. FieldFox can directly be connected to a LAN cable, or if wired LAN is not available, a user supplied wireless router can be configured to work with FieldFox. FieldFox does not include a wireless router.

### FieldFox app without Option 030

The FieldFox app can be installed on an iOS device independent of the presence of Option 030 on the analyzer. Without Option 030, users can view the live display screen of their FieldFox remotely but cannot control the instrument. With 030 purchased and installed on their FieldFox, users can both view and control their FieldFox. Control refers to the ability to press hardkeys, softkeys, make or change measurements, etc.

Option 030 does not include the iOS device itself. Users must supply their own iOS device. Option 030 is a license on the FieldFox analyzer.

Option 030 and the FieldFox app are not applicable to Android, BlackBerry, or Windows phone/tablet devices.

## General Information

<b>Calibration cycle</b>	1 year
<b>Weight</b>	
N991xA, N992xA, N993xA	3.0 kg or 6.6 lb. including battery
N995xA, N996xA	3.2 kg or 7.1 lb. including battery
<b>Dimensions: H x W x D</b>	
	292 x 188 x 72 mm (11.5 in x 7.4 in x 2.8 in)

## General Information (continued)

Environmental	
MIL-PRF-28800F Class 2	Operating temperature Storage temperature Operating humidity Random vibration Functional shock Bench drop
Maximum humidity	Maximum relative humidity (non-condensing): 95% relative humidity up to 40°C, decreases linearly to 45% relative humidity at 55°C <sup>1</sup>
Altitude – operating	9,144 m or 30,000 ft (using battery)
Altitude – Non-operating	15,240 m or 50,000 ft
Altitude – AC to DC adapter	3,000 m or 9,840 ft
Ingress protection	
	This product has been type tested to meet the requirements for ingress protection IP53 in accordance with IEC/EN 60529 (IP rating for instrument by itself, with no cover).
Temperature range	
Operating, AC power, spec	-10 to 55°C (14 to 131°F) (-10 to 45°C/14 to 113°F in RTSA mode)
Operating, battery, spec	-10 to 50°C (14 to 122°F)
Operating, battery, typical	-10 to 55°C (14 to 131°F)
Storage, spec <sup>2</sup>	-51 to 71°C (-60 to 160°F)
<b>EMC:</b> Complies with the essential requirements of the European Radio Equipment Directive as well as current editions of the following standards (dates and editions are cited in the Declaration of Conformity):	
	IEC/EN 61326–1
	EN 301 489-1, EN 301 489-19
	CISPR Pub 11 Group 1, Class B
	AS/NZS CISPR 11
	ICES/NMB–001
	This ISM device complies with Canadian ICES-001. Cet appareil ISM est conforme a la norme NMB-001 du Canada.
<b>Radio Equipment (GNSS):</b>	Complies with the essential requirements of the European Radio Equipment Directive: EN 303413
<b>SAFETY:</b> Complies with the essential requirements of the European Low Voltage Directive as well as current editions of the following standards (dates and editions are cited in the Declaration of Conformity):	
	IEC/EN 61010-1
	Canada: CSA C22.2 No. 61010-1
	USA: UL std no. 61010-1
To find a current Declaration of Conformity for a specific Keysight product, go to: <a href="http://www.keysight.com/go/conformity">http://www.keysight.com/go/conformity</a>	
Explosive environment	
	This product has been type tested to meet the requirements for operation in explosive environments in accordance with MIL-STD-810G, Method 511.5, Procedure I.

<sup>1</sup>From 40°C to 55°C, the maximum % relative humidity follows the line of constant dew point.

<sup>2</sup> The battery packs should be stored in an environment with low humidity. Extended exposure to temperature above 45°C could degrade battery performance and life.

## General Information (continued)

<b>Power supply</b>	
External DC input	15 to 19 VDC, 40 watts maximum when battery charging
External AC power adapter	Efficiency level IV
Input	100 to 250 VAC, 50 to 60 Hz, 1.25 to 0.56 A
Output	15 VDC, 4 A
Power consumption	14 watts typical, mode dependent
<b>Battery</b>	
Lithium ion	10.8 V, 4.6 A-h
Operating time	3.5 hours (typical), mode dependent
Charge time	A fully discharged battery takes about 1.5 hours to recharge to 80%. Four hours to 100%.
Discharge temperature limits	—10 to 60°C, ≤ 85% RH
Charge temperature limits	0 to 45°C, ≤ 85% RH
Storage temperature limits	—20 to 50°C, ≤ 85 % RH The battery packs should be stored in an environment with low humidity. Extended exposure to temperatures above 45°C could degrade battery performance and life.
<b>Test port connectors</b>	
≤ 18 GHz models	Type-N (f)
26.5 GHz models	3.5 mm (m) for FieldFox microwave analyzer, N9918A and FieldFox microwave VNA analyzer, N9928A. On FieldFox SA N9938A, you may choose 3.5 mm (m) or Type-N (f). Type-N (f) port connector is not available for the 26.5 GHz microwave analyzer, N9918A or 26.5 GHz microwave VNA analyzer, N9928A
≥ 32 GHz models	NMD 2.4mm (m), torque .9 Nm or 8 in-lb, use torque wrench N9910X-886
<b>Display</b>	
	6.5" transfective color LCD-LED backlit
<b>Headphone jack connector</b>	
	3.5 mm (1/8 inch) miniature audio jack
<b>USB-A, 2-ports</b>	
	Hi-speed USB 2.0
<b>Mini USB, 1 port<sup>1</sup></b>	
	Hi-speed USB 2.0; used for SCPI programming; USBTMC (USB IEEE488)
<b>Keyboard</b>	
	USB keyboards are supported (user must supply their own keyboard)
<b>LAN</b>	
Connector	RJ-45 Used for programming, data saving, remote control, and connection to DataLink software
N991xA, N992xA, N993xA	100/10 base-T (auto switching)
N995xA, N996xA	1000/100/10 base-T (auto switching) SCPI over LAN using sockets and VX11 (LAN IEEE488); HTTP

<sup>1</sup> SCPI over USB for the N991x/2x/3x models is only available for serial number prefix starting with MY5607/SG5607/US5607 or upgraded with Option N9910HU-100/200/300/400.

## General Information (continued)

<b>Programming</b>	SCPI, using the built-in LAN interface, BenchVue
<b>Languages</b>	English, Spanish, German, Italian, French, Russian, Japanese, Chinese, Turkish, Korean, and Portuguese
<b>Preset</b>	User preset for both mode preset and complete system preset
<b>Limit lines</b>	<p>The limit line capabilities listed in this section apply to the cable and antenna analyzer, network analyzer and spectrum analyzer modes in all FieldFox analyzers.</p> <ul style="list-style-type: none"><li>• Limit lines can be a combination of horizontal lines, sloping lines, or discrete data points</li><li>• Limit types: Fixed or relative</li><li>• Each trace can have its own limit line</li><li>• Limit lines can be built from a current trace</li><li>• Limit segments &gt; 100, limited by memory size</li><li>• Max limit line number of points: 10,001</li><li>• Beep: Beep off, Beep on fail, Beep on pass</li><li>• Pass/fail warning: on/off</li><li>• Offset and margin: An increase or decrease in the limit line</li><li>• Save/recall limit lines</li></ul>
<b>Data storage</b>	
Internal	Internal Minimum: 4 GB Minimum states and traces: 1000
External	Supports USB 2.0 compatible memory devices and SD/SDHC memory cards
Data types	Trace, trace+state, picture (png), data (csv), S1P, S2P
<b>Secure operation</b>	
Frequency blanking	For protection of sensitive data all frequency information can be turned off.
Erase user data	All user data can be erased on a FieldFox analyzer. For more information visit: <a href="http://www.keysight.com/find/securefieldfox">http://www.keysight.com/find/securefieldfox</a>
<b>Reference out/trigger out</b>	
Connector	SMB (m), 50 $\Omega$
Output amplitude	$\geq 0$ dBm
Frequency	10 MHz (1 + frequency reference accuracy)
Trigger out	Reserved for future use; currently only used for ERTA 2-box handshaking
<b>Reference in/trigger in</b>	
Connector	SMA (f), 50 $\Omega$
Reference input	10 MHz, - 5 to +10 dBm
Trigger input	3.3 or 5 V TTL logic levels



# FieldFox Physical Dimensions

FieldFox models with Type-N test port connectors

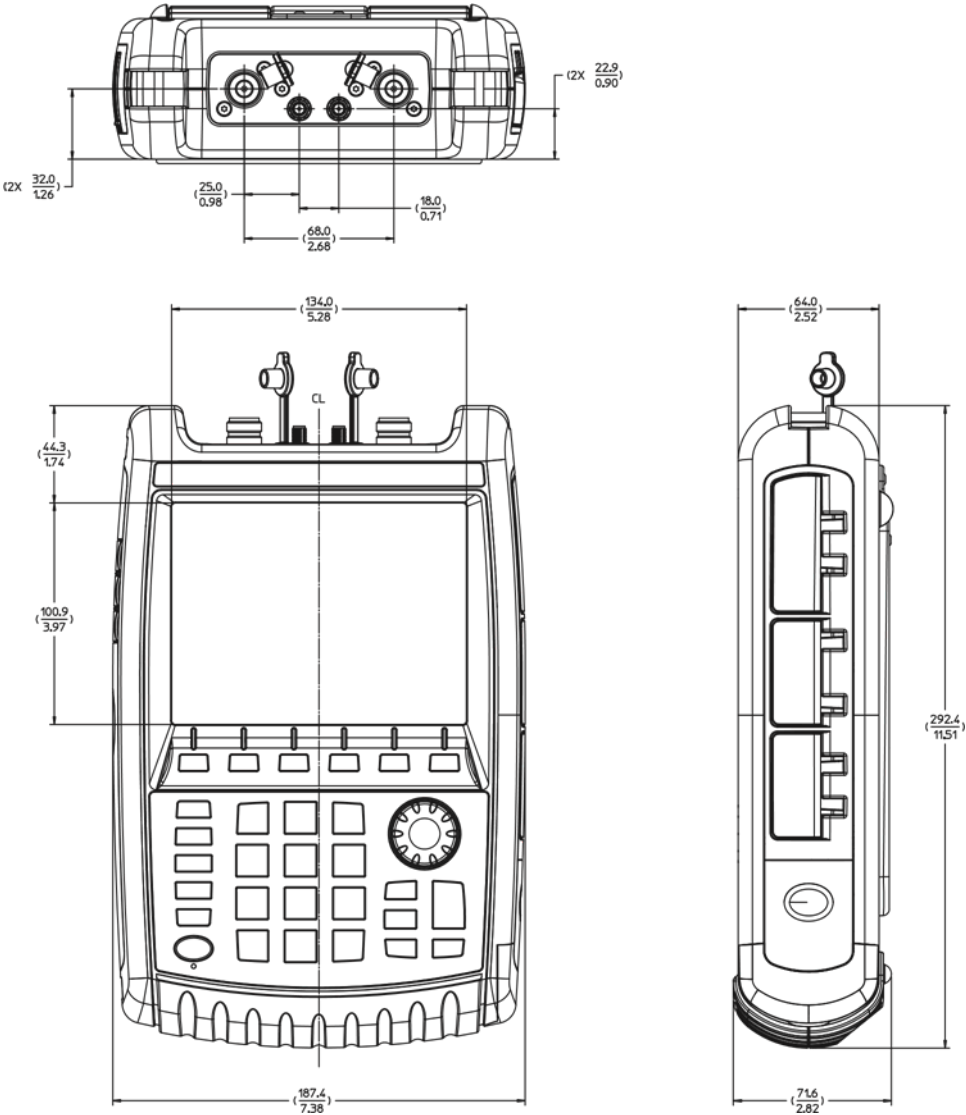

.stp files and rackmount kits are available upon request.

# FieldFox Physical Dimensions (continued)

FieldFox models with 3.5 mm test port connectors

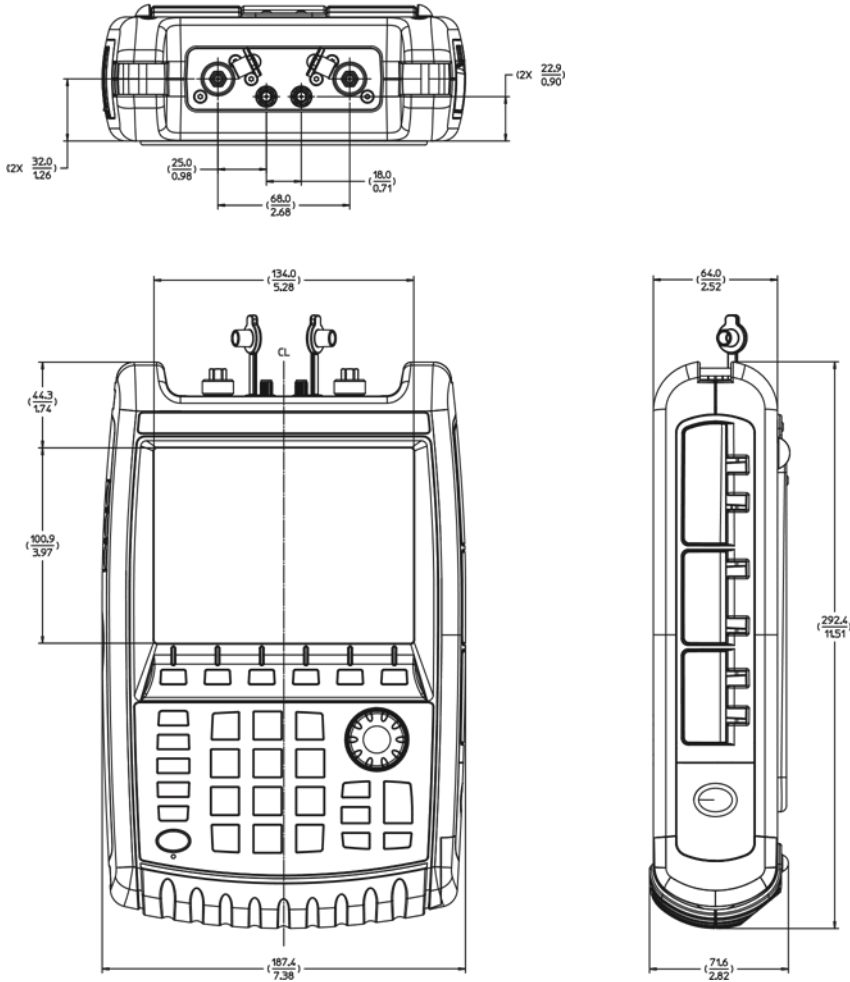

.stp files and rackmount kits are available upon request.

## FieldFox Physical Dimensions (continued)

FieldFox models with 2.4 mm test port connectors

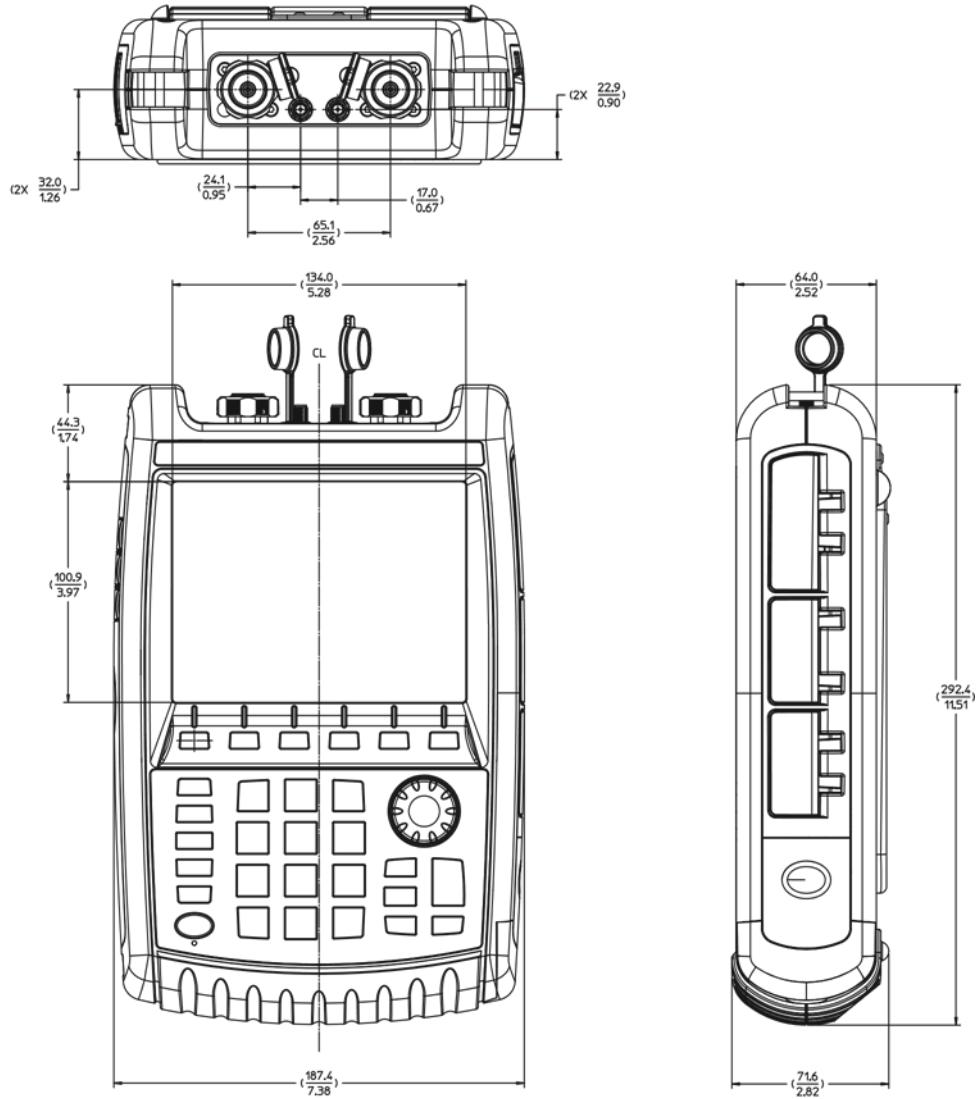

.stp files and rackmount kits are available upon request

## Carry Precision With You

Every piece of gear in your field kit had to prove its worth. Measuring up and earning a spot is the driving idea behind Keysight's FieldFox analyzers. They're equipped to handle routine maintenance, in-depth troubleshooting and anything in between. Better yet, FieldFox delivers precise microwave measurements—wherever you need to go. Add FieldFox to your kit and carry precision with you.

Related Literature	Publication Number
FieldFox Handheld Analyzers, Configuration Guide	5990-9836EN
FieldFox Handheld Analyzers, Technical Overview	5992-0772EN
FieldFox N9923A RF Vector Network Analyzer, Technical Overview	5990-5087EN
FieldFox N9923A RF Vector Network Analyzer, Data Sheet	5990-5363EN
FieldFox N9912A RF Analyzer, Technical Overview	5989-8618EN
FieldFox N9912A RF Analyzer, Data Sheet	N9912-90006

Download application notes, watch videos, and learn more: [www.keysight.com/find/fieldfox](http://www.keysight.com/find/fieldfox)

Learn more at: [www.keysight.com](http://www.keysight.com)

For more information on Keysight Technologies' products, applications or services, please contact your local Keysight office. The complete list is available at: [www.keysight.com/find/contactus](http://www.keysight.com/find/contactus)

